

MARIZA

Aluminium Druckguss, Glas
 diecast aluminium, glass
 fonte d'aluminium, verre
 gegoten aluminium, glas
 aluminio fundido, vidrio
 pressofusione di alluminio, vetro
 fonta aluminiu, sticla
 valualumiini, lasi
 barwione aluminium, szkło

42 Anthrazit · anthracite

Incl. 1 x SMD-LED, 10 W
 1.100 lm, 3.000 K

247069142



Incl. 1 x SMD-LED, 10 W
 1.100 lm, 3.000 K

247060142

Incl. 1 x SMD-LED, 16 W
 1.800 lm, 3.000 K

447060142

Incl. 1 x SMD-LED, 11 W
 1.150 lm, 3.000 K

547060142

IP44



247069142



247060142



547060142

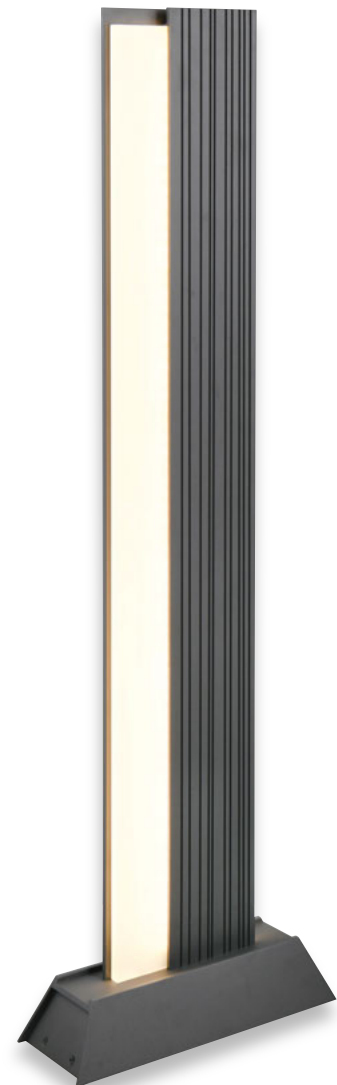

447060142

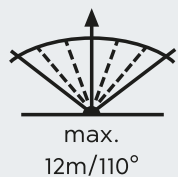
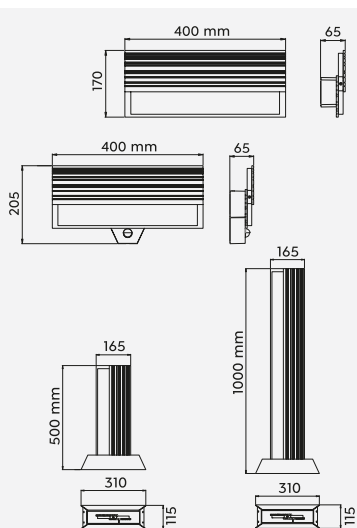

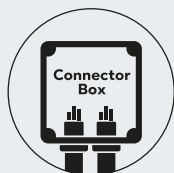

Inkl. Verbinder für Reihenschaltung.

Der Anschlusskasten dieser Leuchte ist für die Aufnahme von zwei Erdzu-
leitungen geeignet, um mehrere Leuchten in Reihenschaltung zu verbinden.

Connector for series connection included.

The connection box of this lighting fixture is fit for mounting two supply cables
in order to connect several luminaires in series.

NESTOS

Aluminium Druckguss, Kunststoff
 diecast aluminium, plastic
 fonte d'aluminium, plastique
 gegoten aluminium, kunststof
 aluminio fundido, plástico
 pressofusione di alluminio, plastica
 fonta aluminiu, plastic
 valualumiini, muovi
 barwione aluminium, plastik

42 Anthrazit · anthracite

Incl. 1 x SMD-LED, 13 W
 1.300 lm, 3.000 K

240960142

IP54

Incl. 1 x SMD-LED, 13 W
 1.300 lm, 3.000 K

240969142

440969142

540969142

IP54



240960142



240969142



440969142



540969142

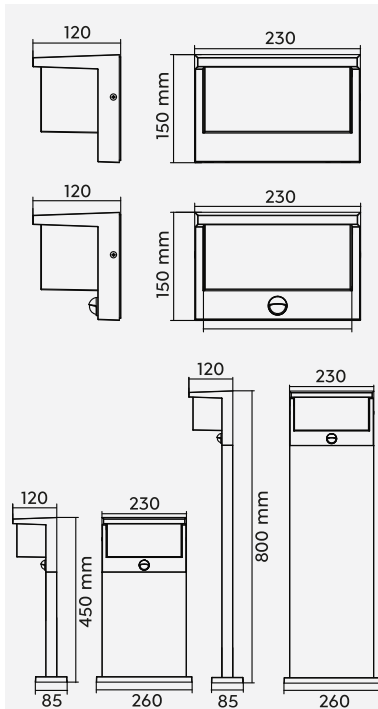

max.
 8m/120°





Aluminium Druckguss
diecast aluminium
fonte d'aluminium
gegoten aluminium
aluminio fundido
pressofusione di alluminio
fonta aluminiu
valualumiini
barwione aluminium

42 Anthrazit · anthracite

Incl. 1 x SMD-LED, 10,5 W
1.100 lm, 2.300 + 3.000 + 4.000 K
277860142

Incl. 1 x SMD-LED, 14 W
1.550 lm, 2.300 + 3.000 + 4.000 K
677860142



Incl. 1 x SMD-LED, 14,5 W
1.450 lm, 2.300 + 3.000 + 4.000 K
477860142
577860142



677860142



277860142

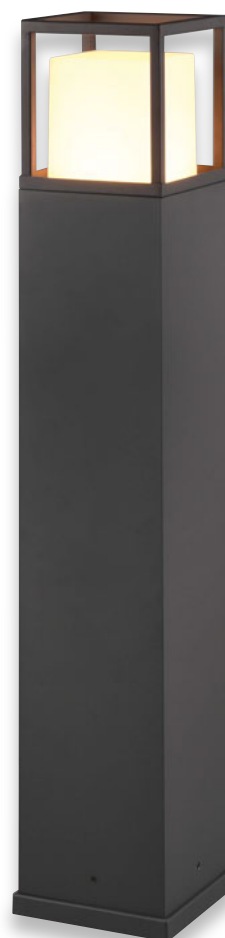

477860142



577860142

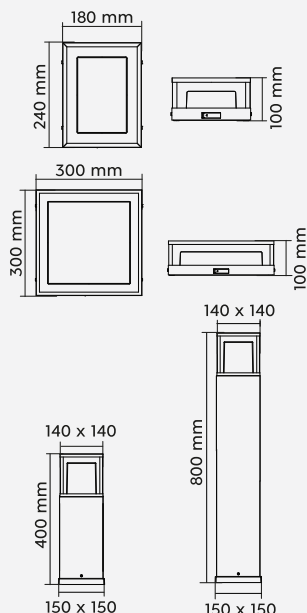

DIP SWITCH

Lichtfarben direkt an der Leuchte einstellbar

Colours directly adjustable at the lamp

Les couleurs de la lumière peuvent être réglées directement sur le luminaire

Lichtkleuren direct instelbaar op de lamp

Tonalidades de luz ajustables directamente en la lámpara

Colori della luce regolabili direttamente sulla lampada

Colori ale luminii reglabile direct de la bec

Valon väri asetettavissa suoraan valaisimesta

Barwy światła można ustawić bezpośrednio na oprawie

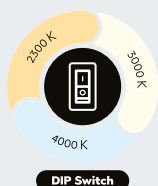

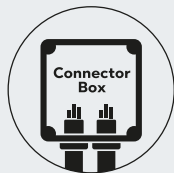

Inkl. Verbinder für Reihenschaltung.

Der Anschlusskasten dieser Leuchte ist für die Aufnahme von zwei Erdzu-
leitungen geeignet, um mehrere Leuchten in Reihenschaltung zu verbinden.

Connector for series connection included.

The connection box of this lighting fixture is fit for mounting two supply cables
in order to connect several luminaires in series.

FUERTE

Aluminium Druckguss, Acryl
diecast aluminium, acryl
fonte d'aluminium, acryl
gegoten aluminium, acryl
aluminio fundido, acrílico
pressofusione di alluminio, acrilico
fonta aluminiu, acrilic
valualumiini, akryyli
barwione aluminium, akryl

42 Anthrazit · anthracite

Incl. 1 x SMD-LED, 10,5 W
1.300 lm, 3.000 K

226260142

IP54

Incl. 1 x SMD-LED, 15 W
1.700 lm, 3.000 K

426260142

526260142

IP54



226260142



426260142



526260142

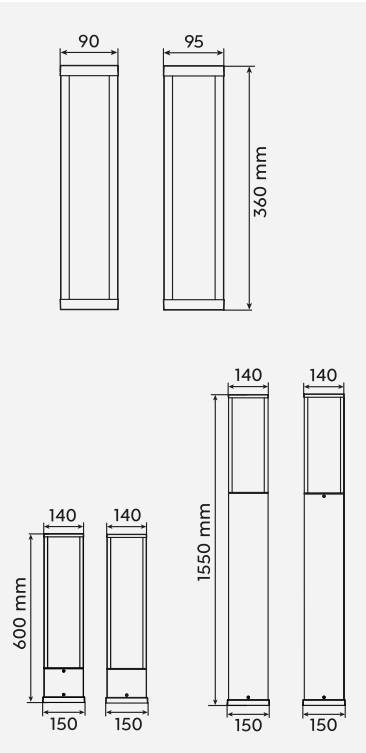



222

SALMON

Aluminium Druckguss,
Holznachbildung
diecast aluminium, wood imitation
fonte d'aluminium, imitation bois
gegoten aluminium, houtimitatie
aluminio fundido,
imitación de madera
pressofusione di alluminio,
effetto legno
fonta aluminiu, imitație de lemn
valualumiini, puujäljitelmä
barwione aluminium,
imitacja drewna

35 Holznachbildung / Anthrazit ·
wood imitation / anthracite

Incl. 1 x SMD-LED, 11 W
1.200 lm, 3.000 K

246969135



Incl. 1 x SMD-LED, 11 W
1.200 lm, 3.000 K

246960135

446960135

546960135

IP44

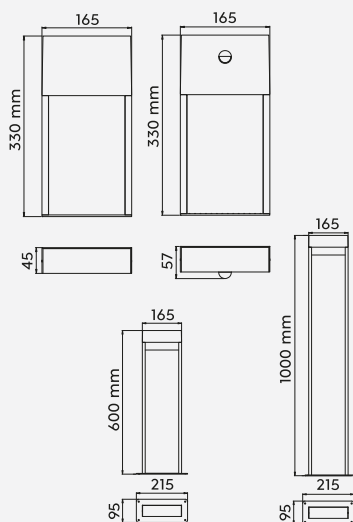

246960135



246969135



446960135



546960135

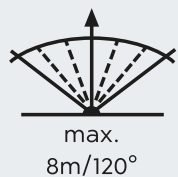

Bewegungssensor
Motion sensor
Détecteur de mouvement
Bewegingssensor
Sensor de movimiento
Sensore di movimento
Senzor de mișcare
Liiketunnistin
Czujnik ruchu



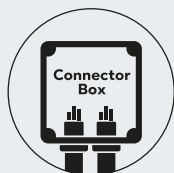

Inkl. Verbinder für Reihenschaltung.

Der Anschlusskasten dieser Leuchte ist für die Aufnahme von zwei Erdzu-
leitungen geeignet, um mehrere Leuchten in Reihenschaltung zu verbinden.

Connector for series connection included.

The connection box of this lighting fixture is fit for mounting two supply cables
in order to connect several luminaires in series.

RENO

Aluminium Druckguss
diecast aluminium
fonte d'aluminium
gegoten aluminium
aluminio fundido
pressofusione di alluminio
fonta aluminu
valualumiini
barwione aluminium

42 Anthrazit · anthracite

Incl. 1 x COB-LED, 4,5 W
450 lm, 3.000 K

IP54

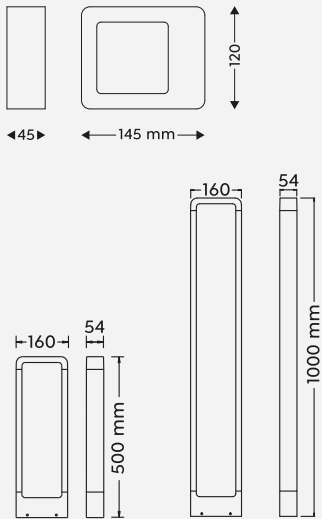

220760142



520760142

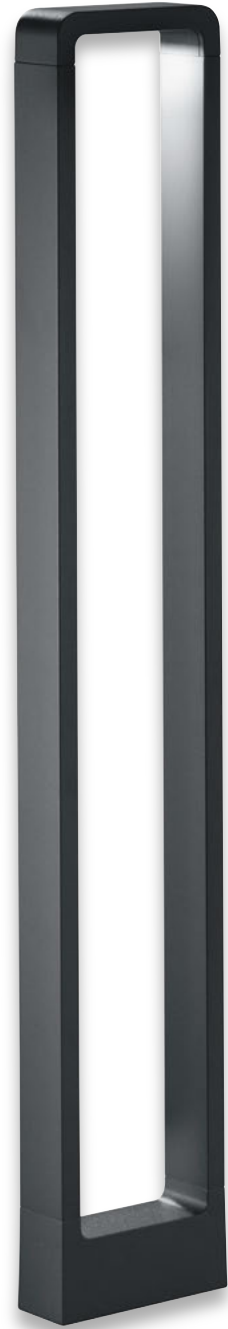

420760142

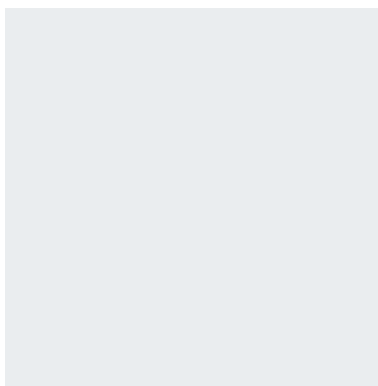



GANGES

Aluminium Druckguss
diecast aluminium
fonte d'aluminium
gegoten aluminium
aluminio fundido
pressofusione di alluminio
fonta aluminii
valualumiini
barwione aluminium

42 Anthrazit · anthracite

Incl. 1 x SMD-LED, 9 W
1.000 lm, 3.000 K

IP54



221760142



521760142



421760142

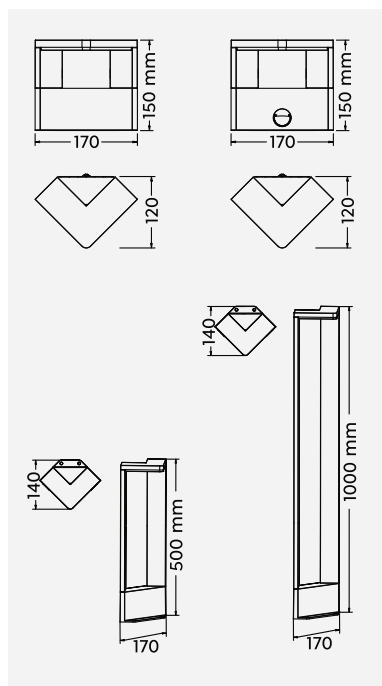



221769142



Bewegungssensor
Motion sensor
Détecteur de mouvement
Bewegingssensor
Sensor de movimiento
Sensore di movimento
Senzor de mișcare
Liiketunnistin
Czujnik ruchu

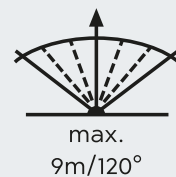

AVON

Aluminium Druckguss, Acryl
 diecast aluminium, acryl
 fonte d'aluminium, acryl
 gegoten aluminium, acryl
 aluminio fundido, acrílico
 pressofusione di alluminio, acrilico
 fonta aluminiu, acrilic
 valualumiini, akryyli
 barwione aluminium, akryl

42 Anthrazit · anthracite

Incl. 1 x SMD-LED, 7 W
 800 lm, 3.000 K

270660142

470660142

570660142



Incl. 2 x SMD-LED, 7 W
 2 x 800 lm, 3.000 K

270660242

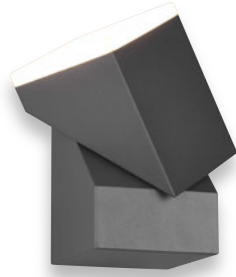

270660142



270660242



570660142



470660142

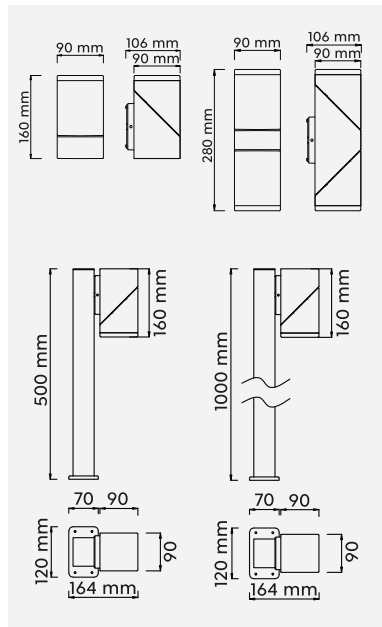



Aluminium Druckguss, Acryl
diecast aluminium, acryl
fonte d'aluminium, acryl
gegoten aluminium, acryl
aluminio fundido, acrílico
pressofusione di alluminio, acrilico
fonta aluminiu, acrilic
valualumiini, akryyli
barwione aluminium, akrjl

42 Anthrazit · anthracite

Incl. 1 x SMD-LED, 7 W
800 lm, 3.000 K

270669142



Incl. 2 x SMD-LED, 7 W
2 x 800 lm, 3.000 K

270669242

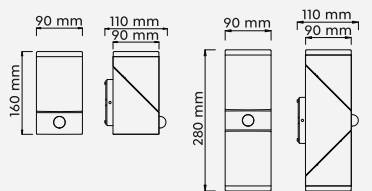

270669142

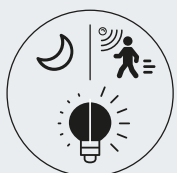

Die Leuchte verfügt über ein Orientierungslicht, das sich bei Dämmerung oder Dunkelheit automatisch einschaltet. Wird eine Bewegung erfasst, schaltet die Leuchte von Orientierungslicht auf volle Lichtleistung.

The luminaire has an orientation light that switches on automatically at dusk or in the dark. If movement is detected, the luminaire switches from orientation light to full light output.



max.
6m/100°

PEARL

Aluminium Druckguss, Kunststoff
 diecast aluminium, plastic
 fonte d'aluminium, plastique
 gegoten aluminium, kunststof
 aluminio fundido, plástico
 pressofusione di alluminio, plastica
 fonta aluminiu, plastic
 valualumiini, muov
 barwione aluminium, plastik

42 Anthrazit · anthacite

Incl. 1 x SMD-LED, 8 W
 900 lm, 3.000 K



221169142



521169142



421169142

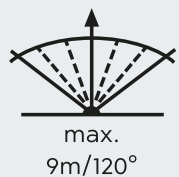
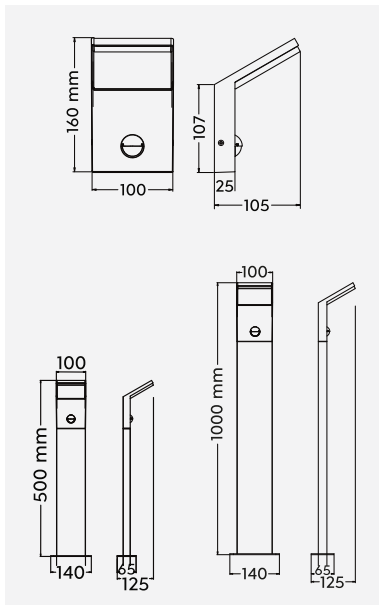

Bewegungssensor
 Motion sensor
 Détecteur de mouvement
 Bewegungssensor
 Sensor de movimiento
 Sensore di movimento
 Senzor de mişcare
 Liiketunnistin
 Czujnik ruchu





PEARL

Aluminium Druckguss, Kunststoff
diecast aluminium, plastic
fonte d'aluminium, plastique
gegoten aluminium, kunststof
aluminio fundido, plástico
pressofusione di alluminio, plastica
fonta aluminiu, plastic
valualumiini, muovi
barwione aluminium, plastik

42 Anthrazit · anthacite

Incl. 1 x SMD-LED, 8 W
900 lm, 3.000 K

IP54

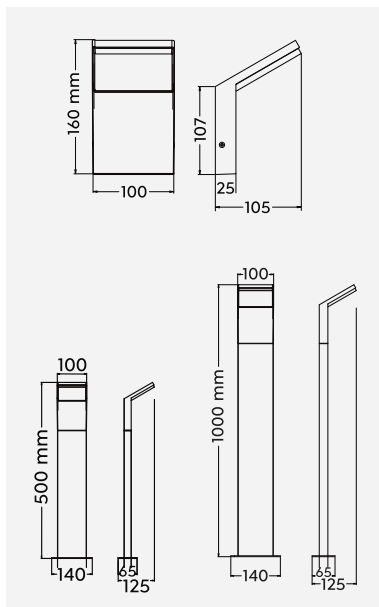

221160142



521160142



421160142





NELSON

Aluminium Druckguss
diecast aluminium
fonte d'aluminium
gegoten aluminium
aluminio fundido
pressofusione di alluminio
fonta aluminii
valualumiini
barwione aluminium

42 Anthrazit · anthracite

Incl. 1 x SMD-LED, 8 W
900 lm, 3.000 K

IP54

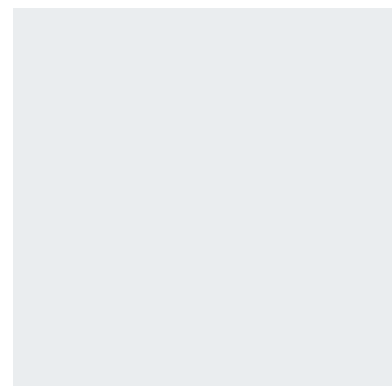
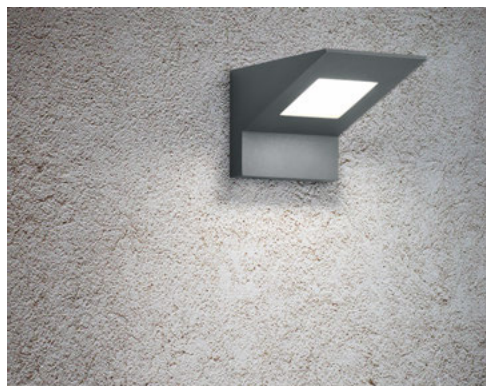
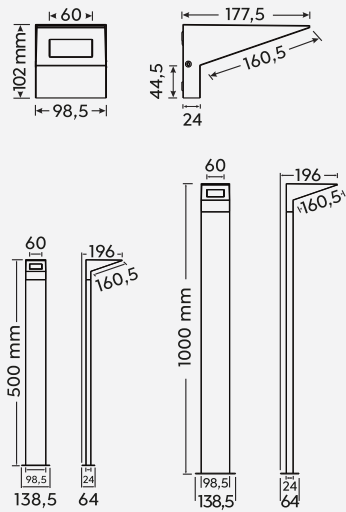

NELSON

Aluminium Druckguss
diecast aluminium
fonte d'aluminium
gegooten aluminium
aluminio fundido
pressofusione di alluminio
fonta aluminiu
valualumiini
barwione aluminium

42 Anthrazit · anthracite

Incl. 1 x SMD-LED, 8 W
900 lm, 3.000 K

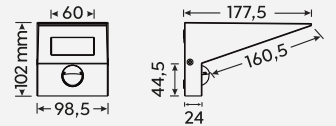

225369142



Bewegungssensor
Motion sensor
Décteur de mouvement
Bewegingssensor
Sensor de movimiento
Sensore di movimento
Senzor de mişcare
Liiketunnistin
Czujnik ruchu

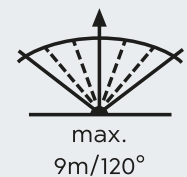

RHINE

Aluminium Druckguss, Kunststoff
 diecast aluminium, plastic
 fonte d'aluminium, plastique
 gegoten aluminium, kunststof
 aluminio fundido, plástico
 pressofusione di alluminio, plastica
 fonta aluminiu, plastic
 valualumiini, muov
 barwione aluminium, plastik

42 Anthrazit · anthracite

Incl. 2 x SMD-LED, 4,5 W
 2 x 450 lm, 3.000 K

221660242

221669242

Incl. 2 x SMD-LED, 5,5 W
 2 x 700 lm, 3.000 K

421660242

521660242

IP54



221669242



221660242



521660242



421660242

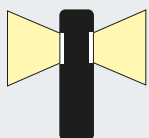
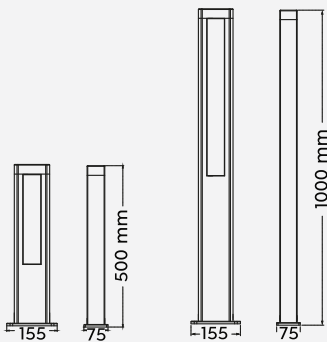
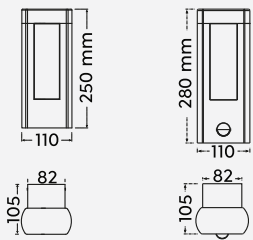



Bewegungssensor
Motion sensor
Décteur de mouvement
Bewegingssensor
Sensor de movimiento
Sensore di movimento
Senzor de mişcare
Liiketunnistin
Czujnik ruchu

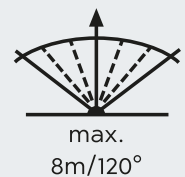

DAWSON

Aluminium Druckguss, Acryl
diecast aluminium, acryl
fonte d'aluminium, acryl
gegoten aluminium, acryl
aluminio fundido, acrílico
pressofusione di alluminio, acrilico
fonta aluminiu, acrilic
valualumiini, akryyli
barwione aluminium, akryl

42 Anthrazit · anthracite

Incl. SMD-LED, 7 W
800 lm, 2.300 + 3.000 + 4.000 K
246360142

Incl. SMD-LED, 8 W
900 lm, 2.300 + 3.000 + 4.000 K
246360242

Incl. SMD-LED, 11 W
1.300 lm, 2.300 + 3.000 + 4.000 K
246360342

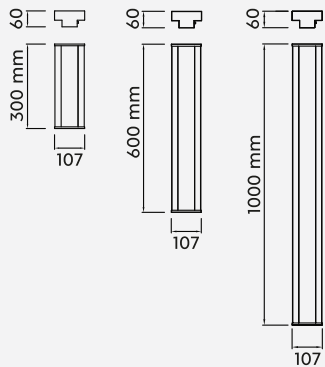

246360142



246360342



246360242

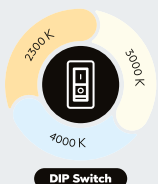

DIP SWITCH

Lichtfarben direkt an der Leuchte einstellbar

Colours directly adjustable at the lamp

Les couleurs de la lumière peuvent être réglées directement sur le luminaire

Lichtkleuren direct instelbaar op de lamp

Tonalidades de luz ajustables directamente en la lámpara

Colori della luce regolabili direttamente sulla lampada

Colori ale luminii reglabile direct de la bec

Valon väri asetettävissa suoraan valaisimesta

Barwy światła można ustawić bezpośrednio na oprawie



MARNE

Aluminium Druckguss, Acryl
diecast aluminium, acryl
fonte d'aluminium, acryl
gegoten aluminium, acryl
aluminio fundido, acrílico
pressofusione di alluminio, acrilico
fonta aluminiu, acrilic
valualumiini, akryyli
barwione aluminium, akryl

42 Anthrazit · anthracite

Incl. SMD-LED, 5,5 W
600 lm, 3.000 K

247360142

Incl. SMD-LED, 8,5 W
1.000 lm, 3.000 K

247360242

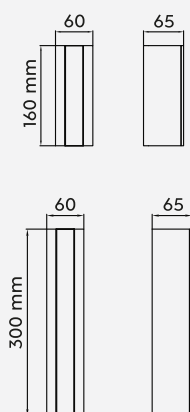

247360142



247360242

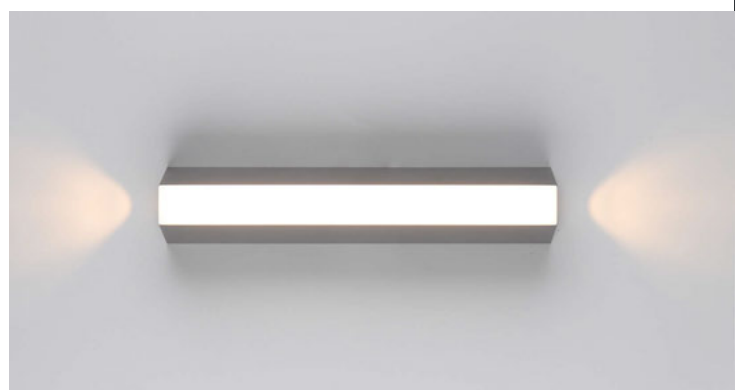



HORTON

Aluminium Druckguss
 diecast aluminium
 fonte d'aluminium
 gegoten aluminium
 aluminio fundido
 pressofusione di alluminio
 fonta aluminiu
 valualumiini
 barwione aluminium

42 Anthrazit · anthracite

Incl. 1 x SMD-LED, 8 W
 1.000 lm, 3.000 K

226360142



Incl. 1 x SMD-LED, 8 W
 1.000 lm, 3.000 K

226369142

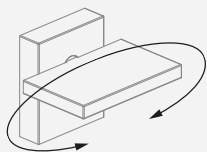
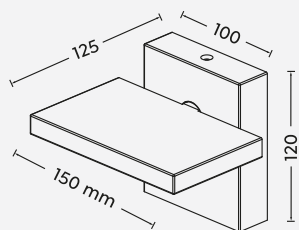

226360142

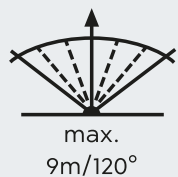

Bewegungssensor
 Motion sensor
 Détecteur de mouvement
 Bewegungssensor
 Sensor de movimiento
 Sensore di movimento
 Senzor de mişcare
 Liiketunnistin
 Czujnik ruchu

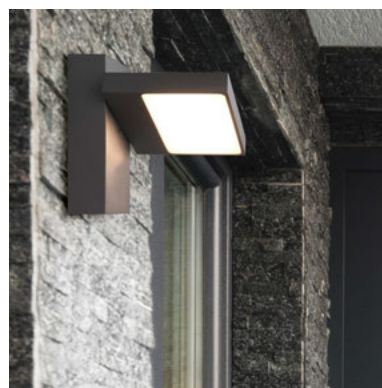

226369142

KANSAS



Aluminium Druckguss, Acryl
diecast aluminium, acryl
fonte d'aluminium, acryl
gegoten aluminium, acryl
aluminio fundido, acrílico
pressofusione di alluminio, acrilico
fonta aluminiu, acrilic
valualumiini, akryyli
barwione aluminium, akryl

42 Anthrazit · anthracite

Incl. 1 x SMD-LED, 10 W
1.000 lm, 3.000 K

246860142



Incl. 1 x SMD-LED, 10 W
1.000 lm, 3.000 K

246869142

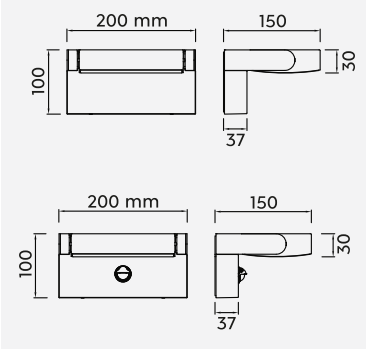

246860142



Bewegungssensor
Motion sensor
Détecteur de mouvement
Bewegingssensor
Sensor de movimiento
Sensore di movimento
Senzor de mișcare
Liiketunnistin
Czujnik ruchu

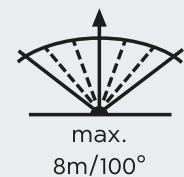

CUANDO

Aluminium Druckguss, Acryl
diecast aluminium, acryl
fonte d'aluminium, acryl
gegoten aluminium, acryl
aluminio fundido, acrílico
pressofusione di alluminio, acrilico
fonta aluminiu, acrilic
valualumiini, akryyli
barwione aluminium, akryl

42 Anthrazit · anthracite

Incl. SMD-LED, 11 W
1.400 lm, 3.000 K

226660242



Incl. SMD-LED, 11 W
1.400 lm, 3.000 K

226669242

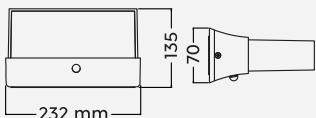
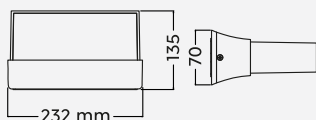

226660242



226669242

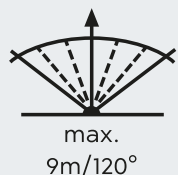

max.
9m/120°



Bewegungssensor
Motion sensor
Détecteur de mouvement
Bewegingssensor
Sensor de movimiento
Sensore di movimento
Senzor de mișcare
Liiketunnistin
Czujnik ruchu

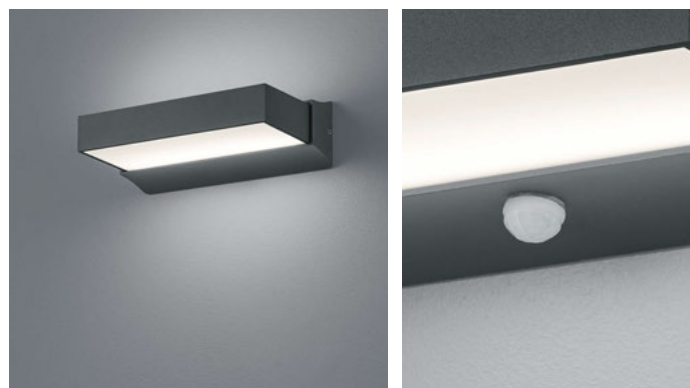

OHIO

Aluminium Druckguss, Kunststoff
diecast aluminium, plastic
fonte d'aluminium, plastique
gegoten aluminium, kunststof
aluminio fundido, plástico
pressofusione di alluminio, plastica
fonta aluminiu, plastic
valualumiini, muovi
barwione aluminium, plastik

42 Anthrazit · anthracite

Incl. 1 x SMD-LED, 7,5 W
800 lm, 3.000 K

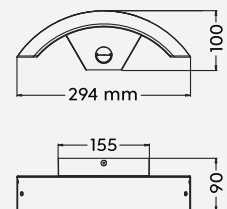

220969142



Bewegungssensor
Motion sensor
Décteur de mouvement
Bewegingssensor
Sensor de movimiento
Sensore di movimento
Senzor de mişcare
Liiketunnistin
Czujnik ruchu

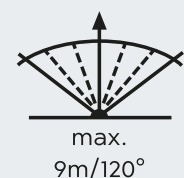

YANGTZE

Aluminium Druckguss, Kunststoff
diecast aluminium, plastic
fonte d'aluminium, plastique
gegoten aluminium, kunststof
aluminio fundido, plástico
pressofusione di alluminio, plastica
fonta aluminiu, plastic
valualumiini, muovi
barwione aluminium, plastik

42 Anthrazit · anthracite

Incl. 1 x SMD-LED, 4,5 W
400 lm, 3.000 K

IP54

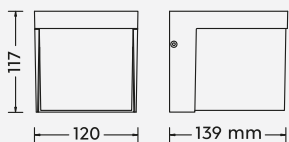

228260142

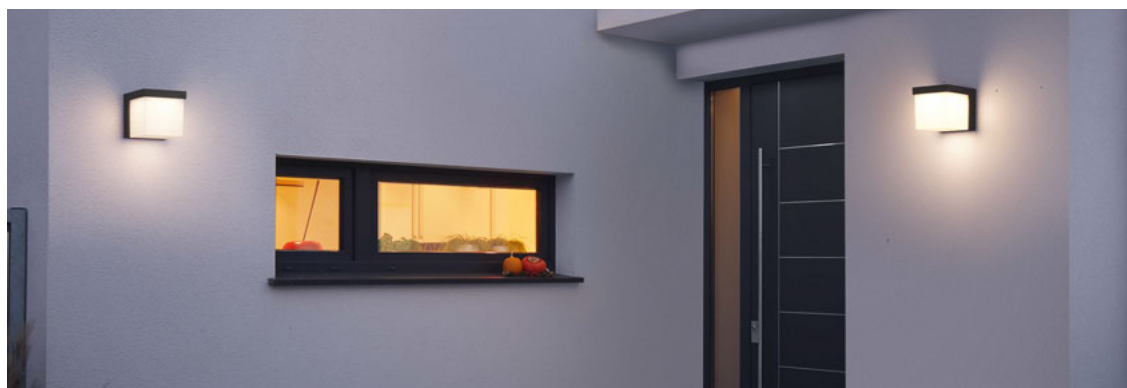

KONDA

Aluminium Druckguss, Kunststoff
diecast aluminium, plastic
fonte d'aluminium, plastique
gegoten aluminium, kunststof
aluminio fundido, plástico
pressofusione di alluminio, plastica
fonta aluminiu, plastic
valualumiini, muovi
barwione aluminium, plastik

42 Anthrazit · anthracite

Incl. 1 x SMD-LED, 9 W
1.200 lm, 3.000 K

IP65

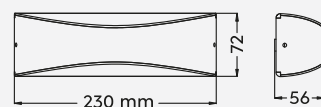

228560242



MERSEY

Aluminium Druckguss, Kunststoff
diecast aluminium, plastic
fonte d'aluminium, plastique
gegoten aluminium, kunststof
aluminio fundido, plástico
pressofusione di alluminio, plastica
fonta aluminiu, plastic
valualumiini, muovi
barwione aluminium, plastik

42 Anthrazit · anthracite

Excl. 2 x E14, max. 40 W

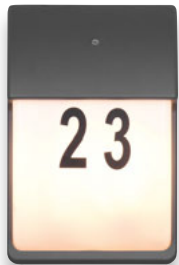
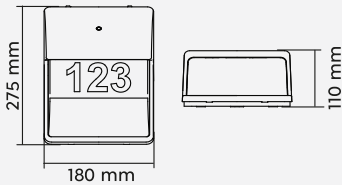

212160242



Empfohlen:
recommended:

LED E14, 3,5 W
320 lm, 3.000 K



983-40



Dämmerungssensor
Dusk sensor
Décteur de crépuscule
Schemeringsensor
Sensor de oscuridad
Sensore crepuscolare
Senzor de lumina/amurg
Hämärätunnistin
Czujnik zmierzchowy

KASAI

Aluminium Druckguss, Kunststoff
diecast aluminium, plastic
fonte d'aluminium, plastique
gegooten aluminium, kunststof
aluminio fundido, plástico
pressofusione di alluminio, plastica
fonta aluminiu, plastic
valualumiini, muovi
barwione aluminium, plastik

42 Anthrazit · anthracite

Incl. 1 x SMD-LED, 9 W
850 lm, 3.000 K

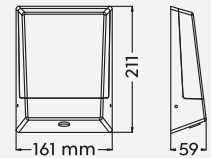

228669142



Dämmerungssensor
Dusk sensor
Décteur de crépuscule
Schemeringsensor
Sensor de oscuridad
Sensore crepuscolare
Sensor de lumina/amurg
Hämärätunnistin
Czujnik zmierzchowy
Alacakaranlık Algılayıcısı



BREG

Aluminium Druckguss, Kunststoff
diecast aluminium, plastic
fonte d'aluminium, plastique
gegoten aluminium, kunststof
aluminio fundido, plástico
pressofusione di alluminio, plastica
fonta aluminiu, plastic
valualumiini, muovi
barwione aluminium, plastik

42 Anthrazit · anthracite

Incl. 1 x SMD-LED, 8,5 W
850 lm, 3.000 K

IP54

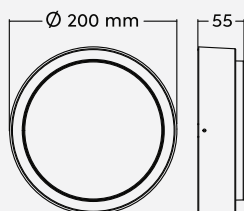

227260142

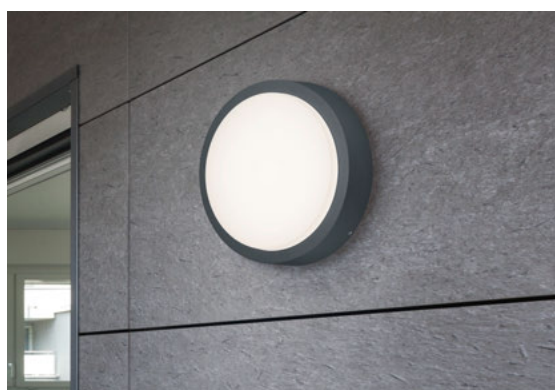

PECOS

Aluminium Druckguss, Kunststoff
diecast aluminium, plastic
fonte d'aluminium, plastique
gegoten aluminium, kunststof
aluminio fundido, plástico
pressofusione di alluminio, plastica
fonta aluminiu, plastic
valualumiini, muovi
barwione aluminium, plastik

42 Anthrazit · anthracite

Incl. 1 x SMD-LED, 6 W
600 lm, 3.000 K

IP54

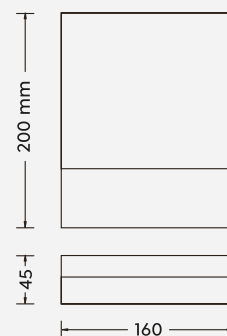

227760142

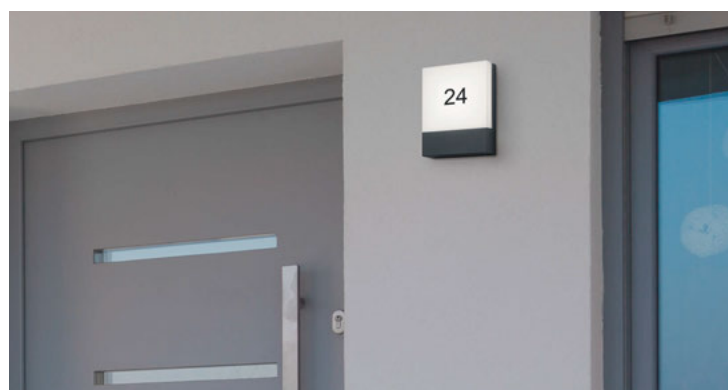
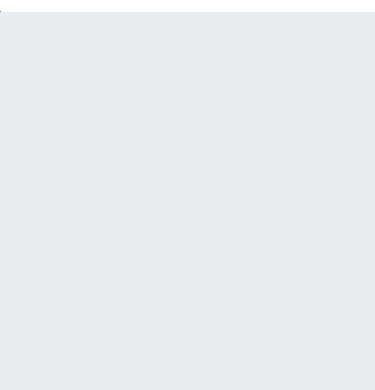

TIMOK

Aluminium Druckguss, Kunststoff
diecast aluminium, plastic
fonte d'aluminium, plastique
gegoten aluminium, kunststof
aluminio fundido, plástico
pressofusione di alluminio, plastica
fonta aluminiu, plastic
valualumiini, muovi
barwione aluminium, plastik

42 Anthrazit · anthracite

Incl. 1 x LED E27, 4,9 W
470 lm, 3.000 K

IP54

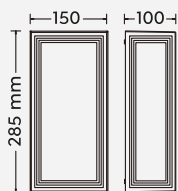

228060142

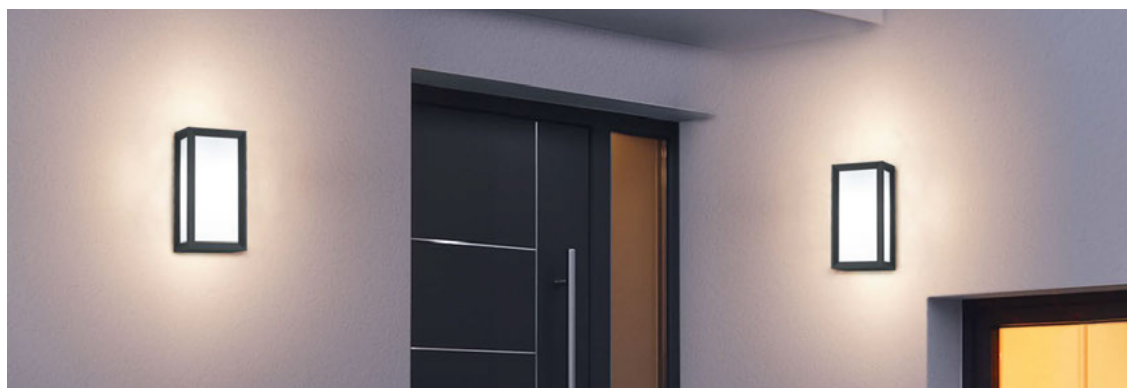

INDUS

Aluminium Druckguss, Kunststoff
diecast aluminium, plastic
fonte d'aluminium, plastique
gegoten aluminium, kunststof
aluminio fundido, plástico
pressofusione di alluminio, plastica
fonta aluminiu, plastic
valualumiini, muovi
barwione aluminium, plastik

42 Anthrazit · anthracite

Incl. 2 x SMD-LED, 4 W
2 x 500 lm, 3.000 K

IP54

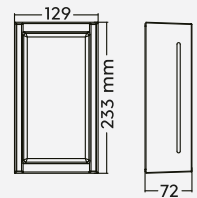

227360142



HONDO

Aluminium Druckguss, Kunststoff
diecast aluminium, plastic
fonte d'aluminium, plastique
gegoten aluminium, kunststof
aluminio fundido, plástico
pressofusione di alluminio, plastica
fonta aluminiu, plastic
valualumiini, muovi
barwione aluminium, plastik

42 Anthrazit · anthracite

Incl. 1 x SMD-LED, 3,5 W
330 lm, 3.000 K

IP54

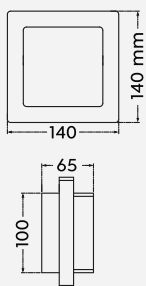

228960142

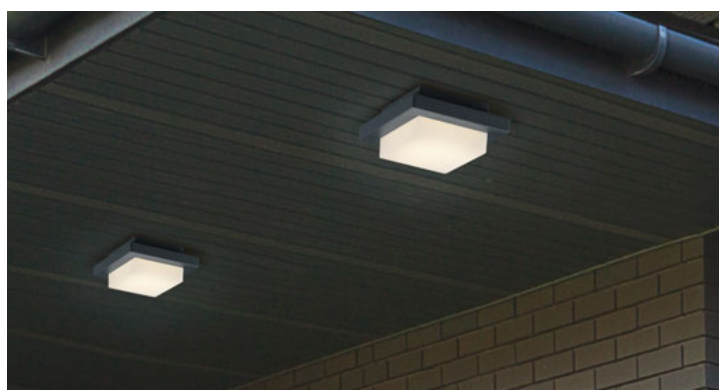

PIAVE



Kunststoff
plastic
plastique
kunststof
plástico
plastica
plastic
muovi
plastik

31 Weiß matt · white mat

42 Anthrazit · anthracite

Incl. SMD-LED, 11 W
1.180 lm, 3.000 K

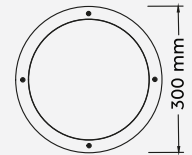

676960131



676960142



Bewegungssensor
Motion sensor
Détecteur de mouvement
Bewegingssensor
Sensor de movimiento
Sensore di movimento
Senzor de mișcare
Liiketunnistin
Czujnik ruchu



max.
10m/150°

TRENT

Aluminium Druckguss
diecast aluminium
fonte d'aluminium
gegoten aluminium
aluminio fundido
pressofusione di alluminio
fonta aluminiu
valualumiini
barwione aluminium

31 Weiß matt · white mat

42 Anthrazit · anthracite

Incl. SMD-LED, 9 W
1.100 lm, 3.000 K

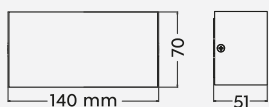

226960231



226960242

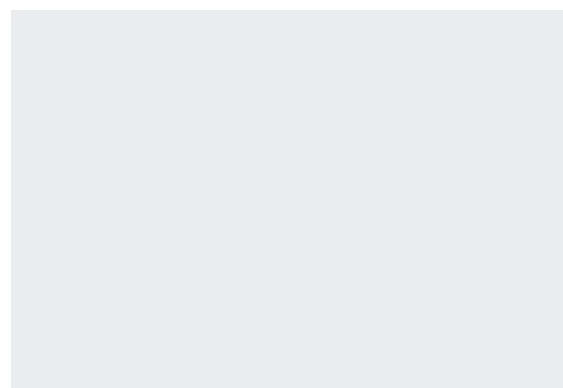

MAYENNE

Aluminium Druckguss, Acryl
diecast aluminium, acryl
fonte d'aluminium, acryl
gegoten aluminium, acryl
aluminio fundido, acrílico
pressofusione di alluminio, acrilico
fonta aluminiu, acrilic
valualumiini, akryyli
barwione aluminium, akryl

35 Holznachbildung · wood imitation

42 Anthrazit · anthracite

Excl. 2 x E14, max. 28 W

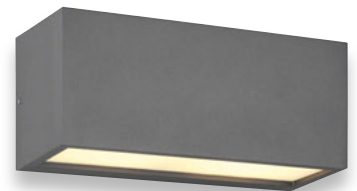
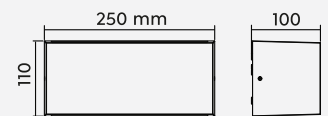

218560242



218560235

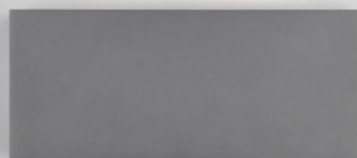

THAMES II

Aluminium Druckguss
diecast aluminium
fonte d'aluminium
gegoten aluminium
aluminio fundido
pressofusione di alluminio
fonta aluminii
valualumiini
barwione aluminium

31 Weiß matt · white mat

42 Anthrazit · anthracite

Incl. 2 x SMD-LED, 2,5 W
2 x 260 lm, 3.000 K

227560231

227560242

Incl. 2 x SMD-LED, 4,5 W
2 x 450 lm, 3.000 K

227660231

227660242

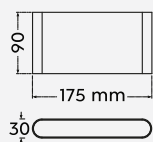
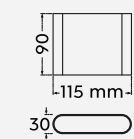

227560231



227560242



227660231



227660242



THAMES II

Aluminium Druckguss
diecast aluminium
fonte d'aluminium
gegoten aluminium
aluminio fundido
pressofusione di alluminio
fonta aluminiu
valualumiini
barwione aluminium

31 Weiß matt · white mat

42 Anthrazit · anthracite

Incl. 2 x SMD-LED, 8 W
2 x 800 lm, 3.000 K

226460231

226460242

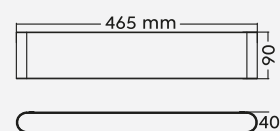

226460231



226460242

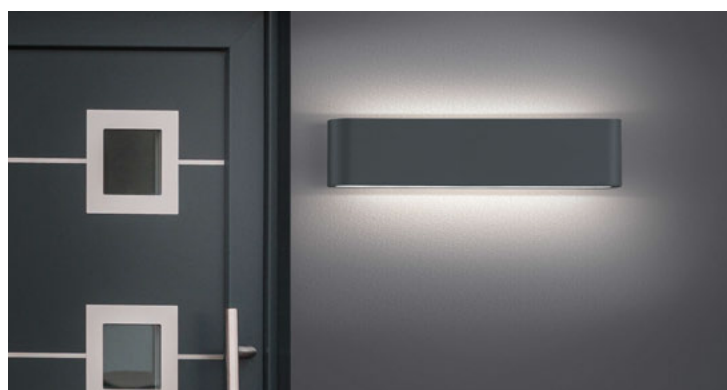

TAY

Aluminium Druckguss
diecast aluminium
fonte d'aluminium
gegoten aluminium
aluminio fundido
pressofusione di alluminio
fonta aluminiu
valualumiini
barwione aluminium

42 Anthrazit · anthracite

Incl. 2 x SMD-LED, 4,5 W
2 x 580 lm, 3.000 K

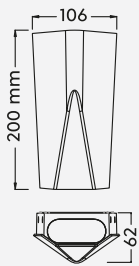

226560242



COLORADO

Aluminium Druckguss
diecast aluminium
fonte d'aluminium
gegoten aluminium
aluminio fundido
pressofusione di alluminio
fonta aluminiu
valualumiini
barwione aluminium

42 Anthrazit · anthracite

Incl. 2 x SMD-LED, 3 W
2 x 300 lm, 3.000 K

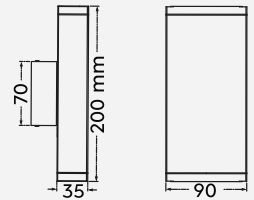

228460242

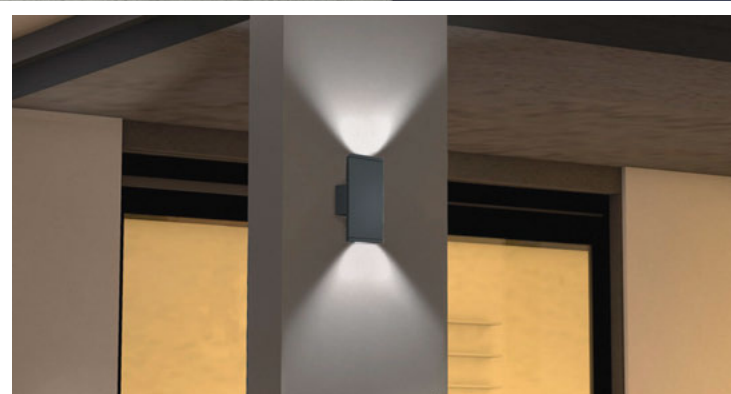
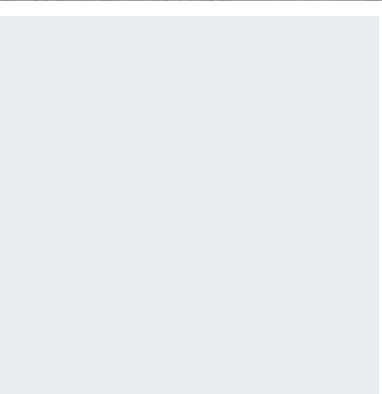

THAMES

Aluminium Druckguss
diecast aluminium
fonte d'aluminium
gegoten aluminium
aluminio fundido
pressofusione di alluminio
fonta aluminiu
valualumiini
barwione aluminium

42 Anthrazit · anthracite

Incl. 2 x SMD-LED, 3 W
2 x 340 lm, 3.000 K

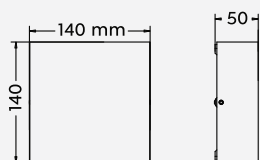

229360242



ADAJA



Aluminium Druckguss
diecast aluminium
fonte d'aluminium
gegoten aluminium
aluminio fundido
pressofusione di alluminio
fonta aluminiu
valualumiini
barwione aluminium

42 Anthrazit · anthracite

Incl. 2 x SMD-LED, 3 W
2 x 350 lm, 3.000 K

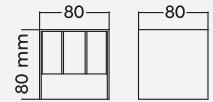

226860242

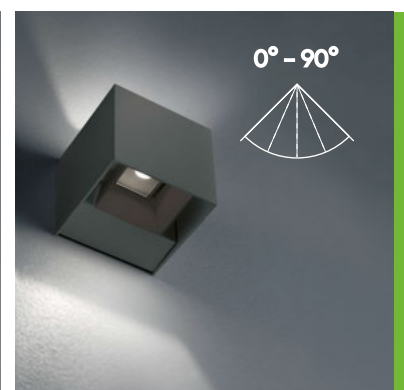

ADOUR

Aluminium Druckguss, Acryl
 diecast aluminium, acryl
 fonte d'aluminium, acryl
 gegoten aluminium, acryl
 aluminio fundido, acrílico
 pressofusione di alluminio, acrilico
 fonta aluminiu, acrilic
 valualumiini, akryyli
 barwione aluminium, akryl

31 Weiß matt · white mat
42 Anthrazit · anthracite

Incl. 1 x SMD-LED, 7,5 W
 750 lm, 2.300 + 3.000 + 4.000 K

245560131
245560142



Incl. 1 x SMD-LED, 7,5 W
 750 lm, 2.300 + 3.000 + 4.000 K

245569131
245569142



245560131



245560142



245569131



245569142

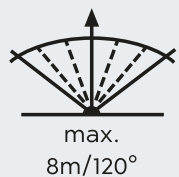
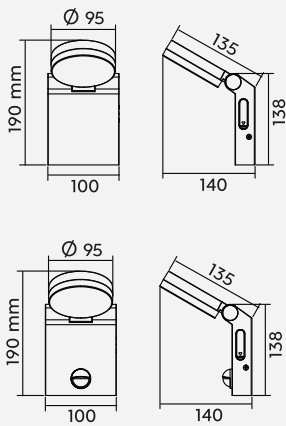



DIP SWITCH

Lichtfarben direkt an der Leuchte einstellbar

Colours directly adjustable at the lamp

Les couleurs de la lumière peuvent être réglées directement sur le luminaire

Lichtkleuren direct instelbaar op de lamp

Tonalidades de luz ajustables directamente en la lámpara

Colori della luce regolabili direttamente sulla lampada

Culori ale luminii reglabile direct de la bec

Valon väri asetettävissa suoraan valaisimesta

Barwy światła można ustawić bezpośrednio na oprawie

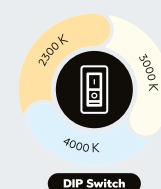

AVISIO

Aluminium Druckguss, Kunststoff
diecast aluminium, plastic
fonte d'aluminium, plastique
gegoten aluminium, kunststof
aluminio fundido, plástico
pressofusione di alluminio, plastica
fonta aluminiu, plastic
valualumiini, muovi
barwione aluminium, plastik

31 Weiß matt · white mat

32 Schwarz matt · black mat

Incl. 2 x SMD-LED, 2 W
2 x 250 lm, 3.000 K

246760231

246760232

Incl. 4 x SMD-LED, 2 W
4 x 250 lm, 3.000 K

646760431

646760432

IP54



246760231



246760232



246760431



246760432

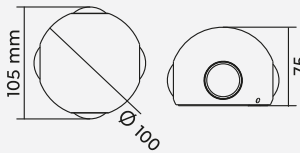
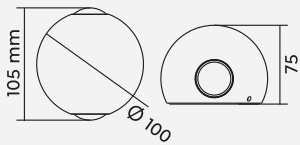



BELLY

Aluminium Druckguss
diecast aluminium
fonte d'aluminium
gegoten aluminium
aluminio fundido
pressofusione di alluminio
fonta aluminiu
valualumiini
barwione aluminium

42 Anthrazit · anthracite

Incl. 1 x SMD-LED, 8,5 W
850 lm, 3.000 K

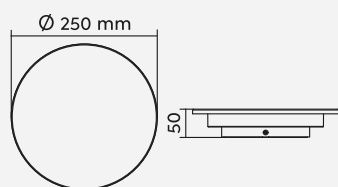

240660142





Aluminium Druckguss
 diecast aluminium
 fonte d'aluminium
 gegoten aluminium
 aluminio fundido
 pressofusione di alluminio
 fonta aluminiu
 valualumiini
 barwione aluminium

42 Anthrazit · anthracite

Incl. 1 x SMD-LED, 7,5 W
 800 lm, 3.000 K

221460142

Incl. 2 x SMD-LED, 9 W
 2 x 900 lm, 3.000 K

221460242

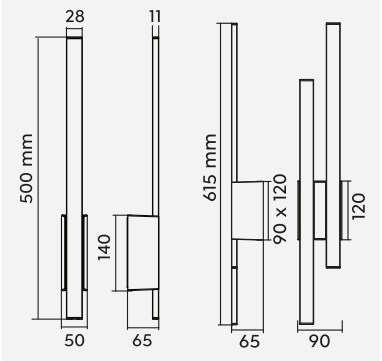

221460142

221460242



CLYDE

Aluminium Druckguss
diecast aluminium
fonte d'aluminium
gegoten aluminium
aluminio fundido
pressofusione di alluminio
fonta aluminiu
valualumiini
barwione aluminium

42 Anthrazit · anthracite

Incl. 2 x SMD-LED, 3 W
2 x 300 lm, 3.000 K

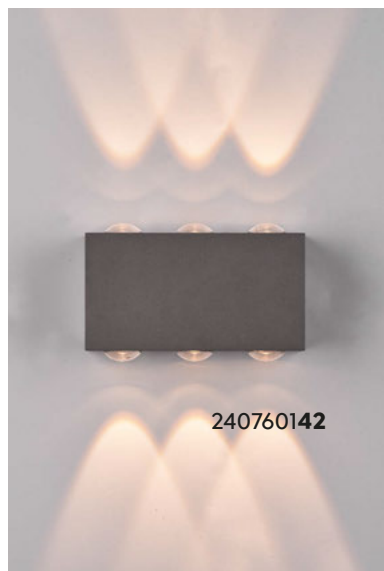
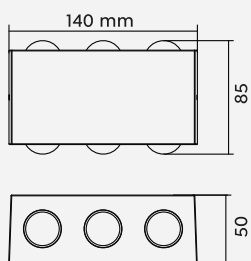

Aluminium Druckguss
 diecast aluminium
 fonte d'aluminium
 gegoten aluminium
 aluminio fundido
 pressofusione di alluminio
 fonta aluminiu
 valualumiini
 barwione aluminium

42 Anthrazit · anthracite

Incl. 1 x SMD-LED, 7,5 W
 850 lm, 2.300 + 3.000 + 4.000 K

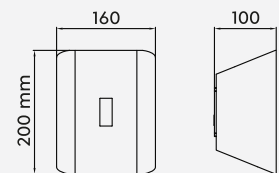

246660342

DIP SWITCH

Lichtfarben direkt an der Leuchte einstellbar

Colours directly adjustable at the lamp

Les couleurs de la lumière peuvent être réglées directement sur le luminaire

Lichtkleuren direct instelbaar op de lamp

Tonalidades de luz ajustables directamente en la lámpara

Colori della luce regolabili direttamente sulla lampada

Culori ale luminii reglabile direct de la bec

Valon väri asetettavissa suoraan valaisimesta

Barwy światła można ustawić bezpośrednio na oprawie

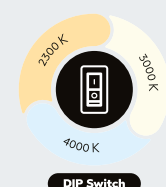

ARDAS

Aluminium Druckguss, Glas
diecast aluminium, glass
fonte d'aluminium, verre
gegoten aluminium, glas
aluminio fundido, vidrio
pressofusione di alluminio, vetro
fonta aluminiu, sticla
valualumiini, lasi
barwione aluminium, szkło

- 24** rostfarbig · rusty
- 31** Weiß matt · white mat
- 32** Schwarz matt · black mat

Excl. 2 x GU10, max. 10 W

212560224

212560231

212560232

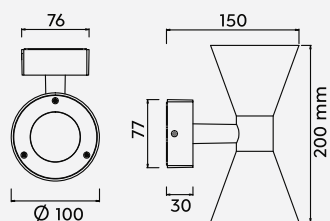

212560232

Empfohlen:
recommended:

LED GU10, 5 W
400 lm, 3.000 K
≥ 110°



955-50



212560224

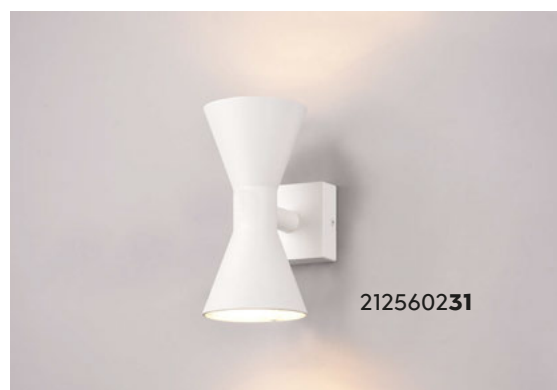

212560231

KAVERI

Aluminium Druckguss
diecast aluminium
fonte d'aluminium
gegooten aluminium
aluminio fundido
pressofusione di alluminio
fonta aluminiu
valualumiini
barwione aluminium

42 Anthrazit · anthracite

Excl. 1 x GU10, max. 5 W



IP44

506060142

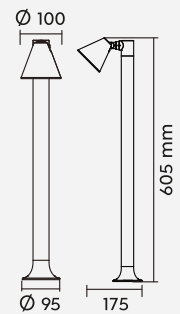
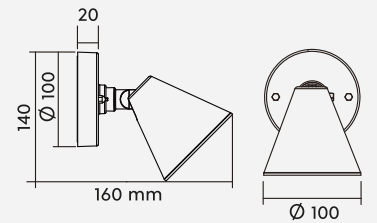

206060142



Empfohlen:
recommended:

LED GU10, 5 W
400 lm, 3.000 K
≈ 110°



955-50

TIBER

Aluminium Druckguss
diecast aluminium
fonte d'aluminium
gegoten aluminium
aluminio fundido
pressofusione di alluminio
fonta aluminiu
valualumiini
barwione aluminium

42 Anthrazit · anthracite

Incl. 1 x SMD-LED, 3 W
300 lm, 3.000 K

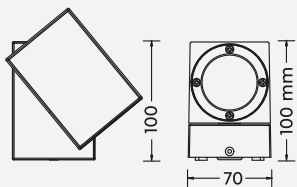

229160142

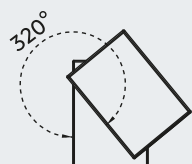

TUNGA

Aluminium Druckguss
diecast aluminium
fonte d'aluminium
gegoten aluminium
aluminio fundido
pressofusione di alluminio
fonta aluminiu
valualumiini
barwione aluminium

42 Anthrazit · anthracite

Incl. 2 x COB-LED, 3,5 W
2 x 420 lm, 3.000 K
222960242

IP54

Incl. 2 x COB-LED, 3,5 W
2 x 420 lm, 3.000 K
222969242

IP54 

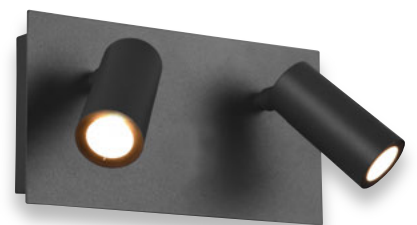
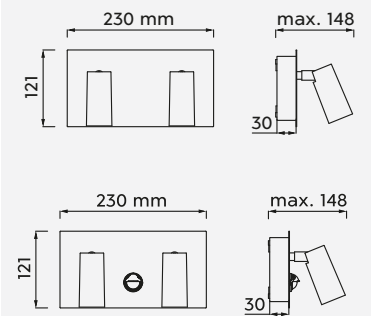

222960242

222969242

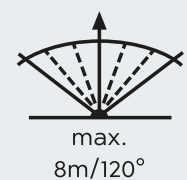

Aluminium Druckguss
 diecast aluminium
 fonte d'aluminium
 gegoten aluminium
 aluminio fundido
 pressofusione di alluminio
 fonta aluminiu
 valualumiini
 barwione aluminium

42 Anthrazit · anthracite

Excl. 1 x GU10, max. 35 W

214260142

214269142

414260142

514260142



Excl. 2 x GU10, max. 35 W

214260242

214269242



214260142



214260242



214269242



214269142



514260142



414260142

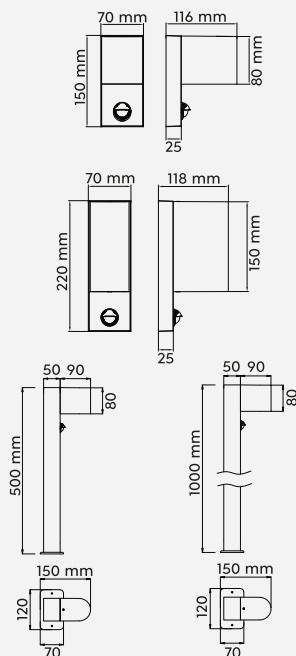

Empfohlen:
 recommended:

LED GU10, 5 W
 400 lm, 3.000 K
 > 110°



955-50

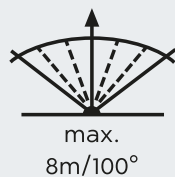

Bewegungssensor
 Motion sensor
 Détecteur de mouvement
 Bewegungssensor
 Sensor de movimiento
 Sensore di movimento
 Senzor de mișcare
 Liiketunnistin
 Czujnik ruchu

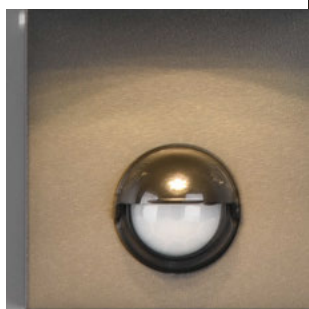

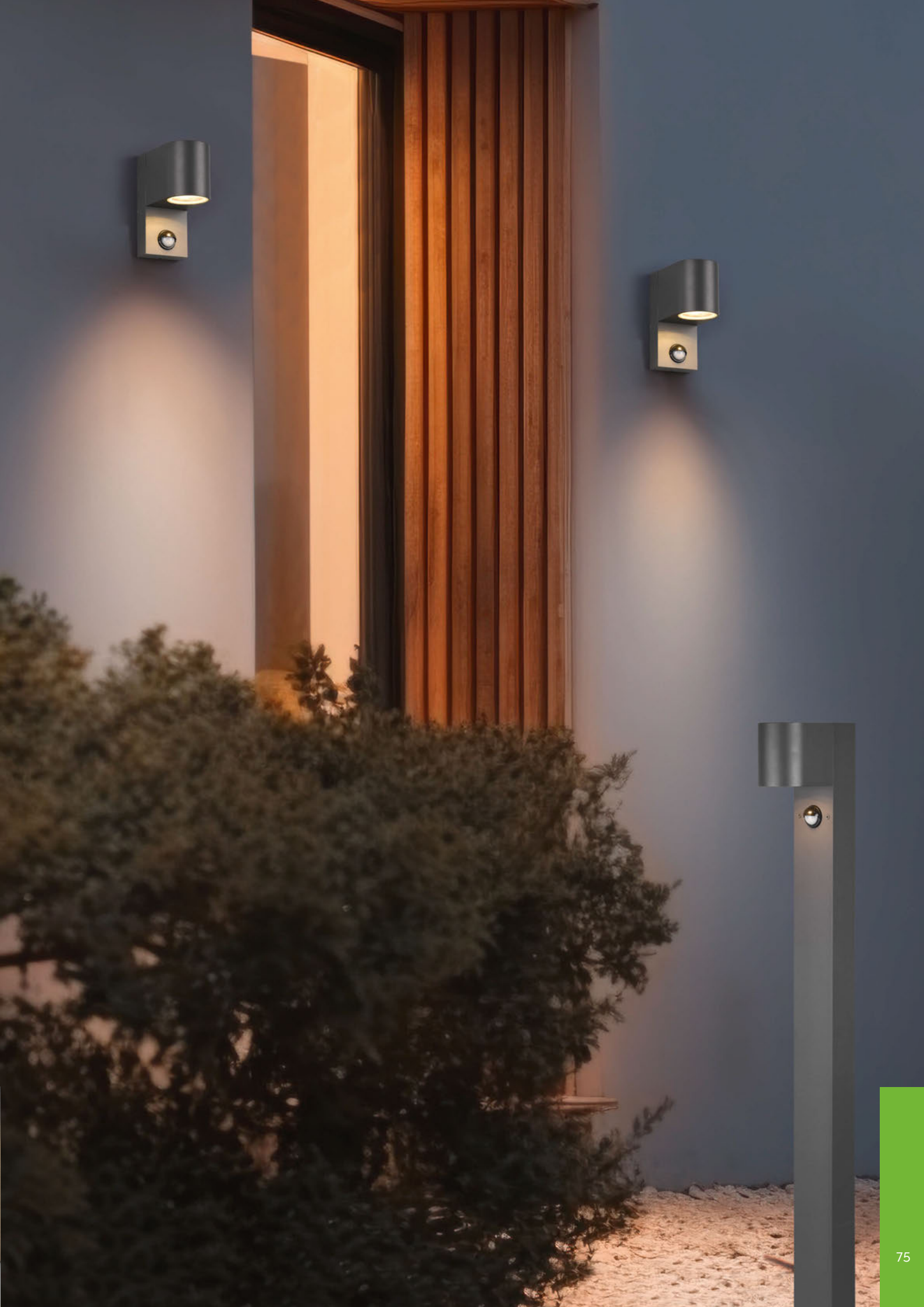

Aluminium Druckguss
 diecast aluminium
 fonte d'aluminium
 gegoten aluminium
 aluminio fundido
 pressofusione di alluminio
 fonta aluminiu
 valualumiini
 barwione aluminium

- 24** rostfarbig · rusty
- 31** Weiß matt · white mat
- 42** Anthrazit · anthracite

Excl. 2 x GU10, max. 35 W

- 204260224**
- 204269224**
- 204260231**
- 204269231**
- 204260242**
- 204269242**



Excl. 1 x GU10, max. 20 W

- 404260142**
- 504260142**



204260242



204269242



504260142



404260142

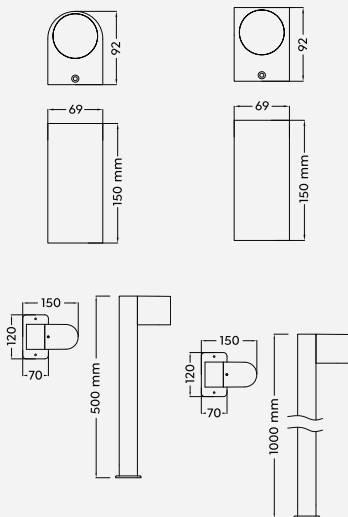

Empfohlen:
 recommended:

LED GU10, 5 W
 400 lm, 3.000 K
 > 110°



955-50



204260224



204260231

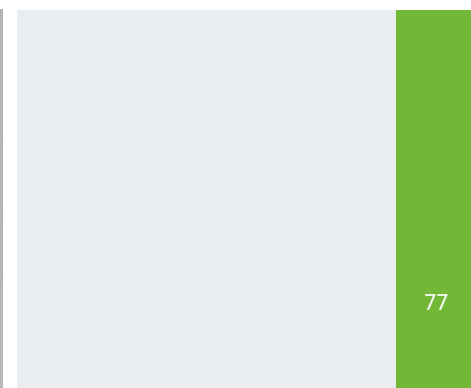

ARDILA

Aluminium Druckguss, Glas
diecast aluminium, glass
fonte d'aluminium, verre
gegoten aluminium, glas
aluminio fundido, vidrio
pressofusione di alluminio, vetro
fonta aluminiu, sticla
valualumiini, lasi
barwione aluminium, szkło

35 Holznachbildung · wood imitation

Excl. 1 x E27, max. 20 W

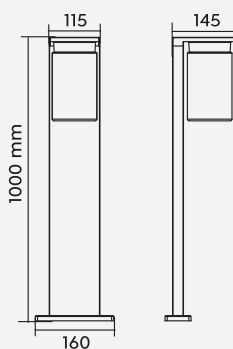
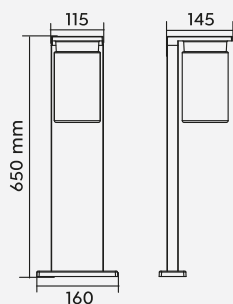
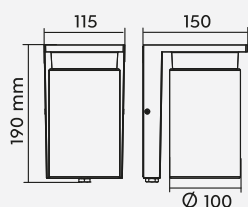

211660135



511660135



411660135

Empfohlen:
recommended:

Filament LED
E27, 4 W
470 lm, 2.700 K



987-400



Dämmerungssensor per Schalter deaktivierbar

On and off switchable dusk sensor

Décteur de crépuscule commutable

Aan en uit schakelbare schemeringsensor

Sensor de oscuridad conmutable on/off

Sensore crepuscolare commutabile on/off

senzor de lumina/amurg on/off

On/off kytkettävä hämärätunnistin

Czujnik zmierzchowy dezaktywowany przez przełącznika

Aç-kapa anahtarlı karanlık sensörü



ARDILA

Aluminium Druckguss, Glas
diecast aluminium, glass
fonte d'aluminium, verre
gegoten aluminium, glas
aluminio fundido, vidrio
pressofusione di alluminio, vetro
fonta aluminiu, sticla
valualumiini, lasi
barwione aluminium, szkło

32 Schwarz matt · black mat

Excl. 1 x E27, max. 40 W

211660132

411660132

511660132



211660132



511660132



411660132

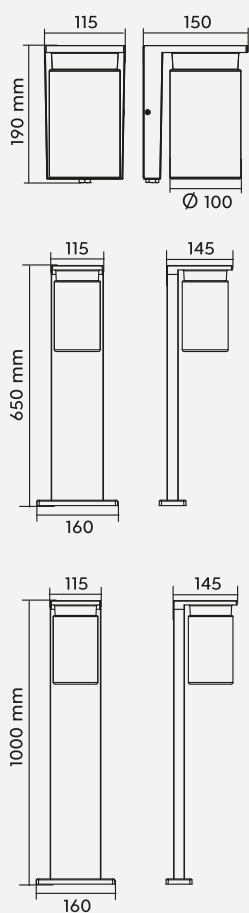

Empfohlen:
recommended:

Filament LED
E27, 4 W
470 lm, 2.700 K



987-400

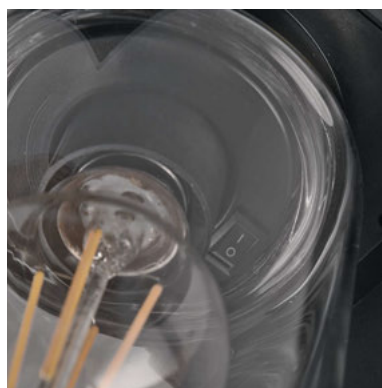

Dämmerungssensor per Schalter deaktivierbar

On and off switchable dusk sensor

Décteur de crépuscule commutable

Aan en uit schakelbare schemeringsensor

Sensor de oscuridad conmutable on/off

Sensore crepuscolare commutabile on/off

senzor de lumina/amurg on/off

On/off kytkettävä hämärätunnistin

Czujnik zmierzchowy dezaktywowany przez przełącznika

Aç-kapa anahtarlı karanlık sensörü



GARONNE

Aluminium Druckguss, Glas
 diecast aluminium, glass
 fonte d'aluminium, verre
 gegoten aluminium, glas
 aluminio fundido, vidrio
 pressofusione di alluminio, vetro
 fonta aluminiu, sticla
 valualumiini, lasi
 barwione aluminium, szkło

42 Anthrazit · anthracite

Excl. 1 x E27, max. 40 W

201860142

401860142

501860142

Excl. 2 x E27, max. 40 W

201860242

601860242



601860242



201860142



201860242



401860142



501860142

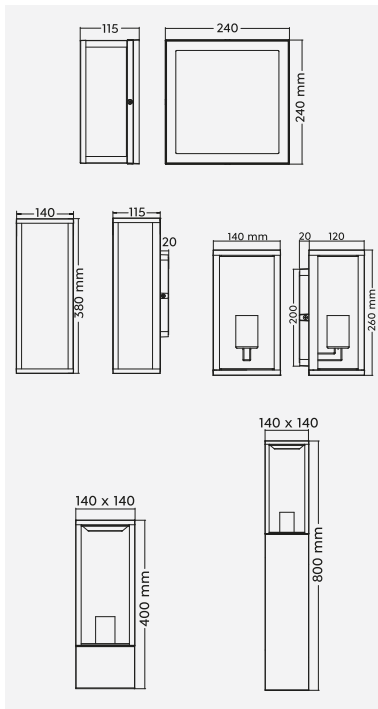

Empfohlen:
 recommended:

Filament LED
 E27, 7 W
 806 lm, 3.000 K



987-600

Empfohlen:
 recommended:

Filament LED
 E27, 4 W
 470 lm, 2.700 K



987-400



GARONNE

Aluminium Druckguss, Glas
diecast aluminium, glass
fonte d'aluminium, verre
gegoten aluminium, glas
aluminio fundido, vidrio
pressofusione di alluminio, vetro
fonta aluminiu, sticla
valualumiini, lasi
barwione aluminium, szkło

42 Anthrazit · anthracite

Excl. 1 x E27, max. 40 W



IP44

401869142

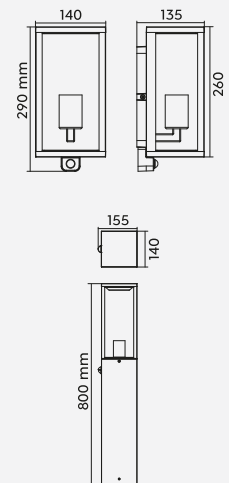

201869142



Bewegungssensor
Motion sensor
Décteur de mouvement
Bewegingssensor
Sensor de movimiento
Sensore di movimento
Senzor de mişcare
Liiketunnistin
Czujnik ruchu

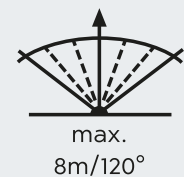

COOPER

Edelstahl, Kunststoff
steel, plastic
acier, plastique
staal, kunststof
acero, plástico
acciaio, plastica
inox, plastic
teräs, muovi
stal, plastik

42 Anthrazit · anthracite

Excl. 1 x E27, max. 40 W



IP44

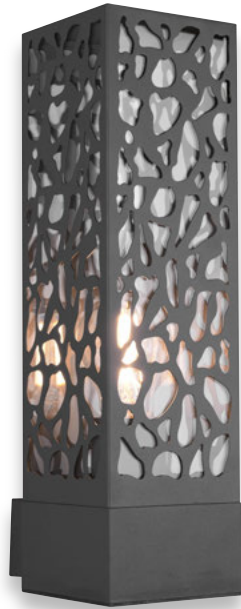

207360142



407360142



507360142

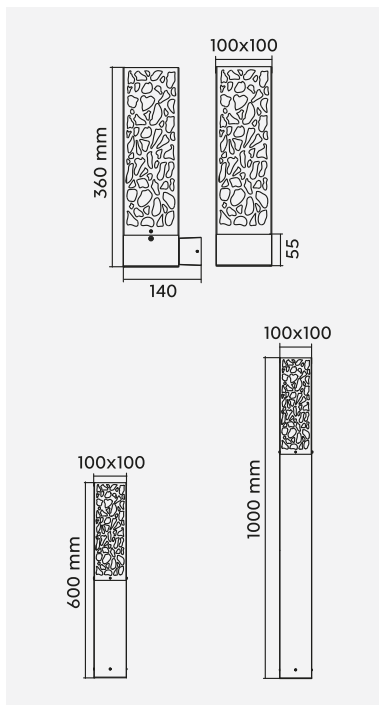

Empfohlen:
recommended:

Filament LED
E27, 4 W
470 lm, 2.700 K



987-400





HOOSIC

Aluminium Druckguss, Kunststoff
 diecast aluminium, plastic
 fonte d'aluminium, plastique
 gegoten aluminium, kunststof
 aluminio fundido, plástico
 pressofusione di alluminio, plastica
 fonta aluminiu, plastic
 valualumiini, muov
 barwione aluminium, plastik

32 Schwarz matt · black mat

Excl. 1 x E27, max. 28 W

222260132

422260132

522260132

Excl. 2 x E27, max. 28 W

222260232



222260132



222260232



422260132



522260132

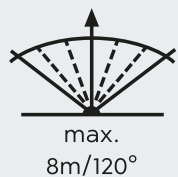
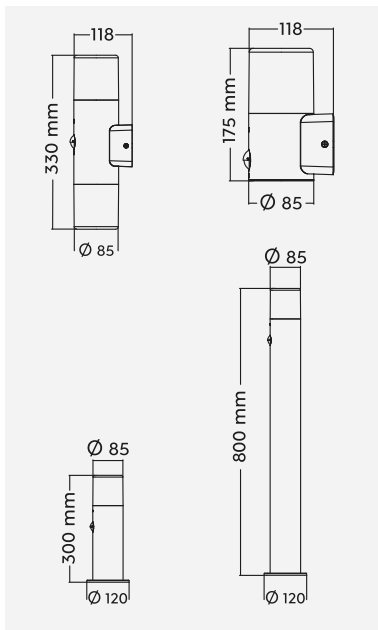

Bewegungssensor
 Motion sensor
 Détecteur de mouvement
 Bewegungssensor
 Sensor de movimiento
 Sensore di movimento
 Senzor de mişcare
 Liiketunnistin
 Czujnik ruchu





HOOSIC

Aluminium Druckguss, Kunststoff
 diecast aluminium, plastic
 fonte d'aluminium, plastique
 gegoten aluminium, kunststof
 aluminio fundido, plástico
 pressofusione di alluminio, plastica
 fonta aluminiu, plastic
 valualumiini, muov
 barwione aluminium, plastik

32 Schwarz matt · black mat

Excl. 1 x E27, max. 28 W

224060132

424060132

524060132

Excl. 2 x E27, max. 28 W

224060232



224060232



224060132



424060132



524060132

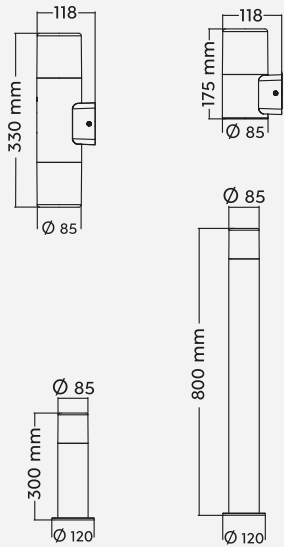

Empfohlen:
 recommended:

LED E27, 4 W
 470 lm, 2.700 K



987-400





HOOSIC

Aluminium Druckguss, Kunststoff
 diecast aluminium, plastic
 fonte d'aluminium, plastique
 gegoten aluminium, kunststof
 aluminio fundido, plástico
 pressofusione di alluminio, plastica
 fonta aluminiu, plastic
 valualumiini, muovi
 barwione aluminium, plastik

42 Anthrazit · anthracite

Excl. 1 x E27, max. 28 W

222260142

422260142

522260142

Excl. 2 x E27, max. 28 W

222260242



222260142



222260242



522260142



422260142

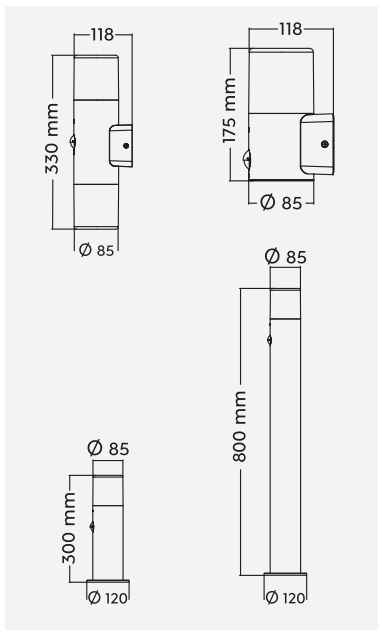

Empfohlen:
 recommended:

LED E27, 4,9 W
 470 lm, 3.000 K



987-60



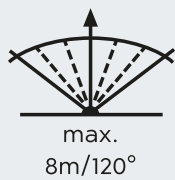

Bewegungssensor
Motion sensor
Détecteur de mouvement
Bewegungssensor
Sensor de movimiento
Sensore di movimento
Senzor de mișcare
Liiketunnistin
Czujnik ruchu



HOOSIC

Aluminium Druckguss, Kunststoff
 diecast aluminium, plastic
 fonte d'aluminium, plastique
 gegoten aluminium, kunststof
 aluminio fundido, plástico
 pressofusione di alluminio, plastica
 fonta aluminiu, plastic
 valualumiini, muovi
 barwione aluminium, plastik

42 Anthrazit · anthracite

Excl. 1 x E27, max. 28 W

224060142

424060142

524060142

Excl. 2 x E27, max. 28 W

224060242



224060142



224060242



424060142



524060142

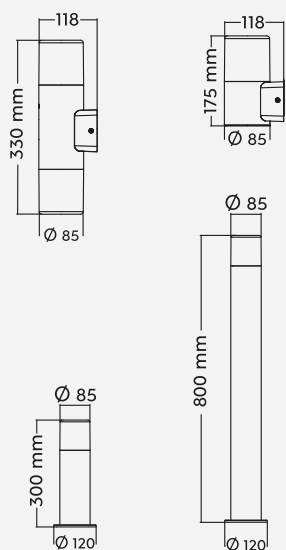

Empfohlen:
 recommended:

LED E27, 4,9 W
 470 lm, 3.000 K



987-60



HOOSIC

Aluminium Druckguss, Kunststoff
diecast aluminium, plastic
fonte d'aluminium, plastique
gegoten aluminium, kunststof
aluminio fundido, plástico
pressofusione di alluminio, plastica
fonta aluminiu, plastic
valualumiini, muovi
barwione aluminium, plastik

42 Anthrazit · anthracite

Excl. 1 x E27, max. 28 W



IP44



424067142



x 2



HOOSIC

Aluminium Druckguss, Kunststoff
 diecast aluminium, plastic
 fonte d'aluminium, plastique
 gegoten aluminium, kunststof
 aluminio fundido, plástico
 pressofusione di alluminio, plastica
 fonta aluminiu, plastic
 valualumiini, muovi
 barwione aluminium, plastik

24 rostfarbig · rusty

Excl. 1 x E27, max. 28 W

222260124

422260124

522260124

Excl. 2 x E27, max. 28 W

222260224



IP44



222260124



222260224



522260124



422260124

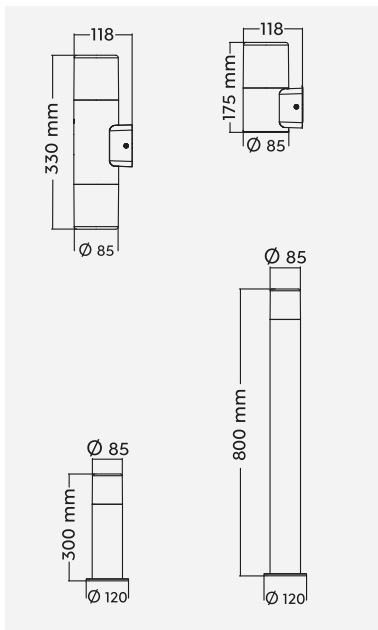

Empfohlen:
 recommended:

LED E27, 4,9 W
 470 lm, 3.000 K



987-60

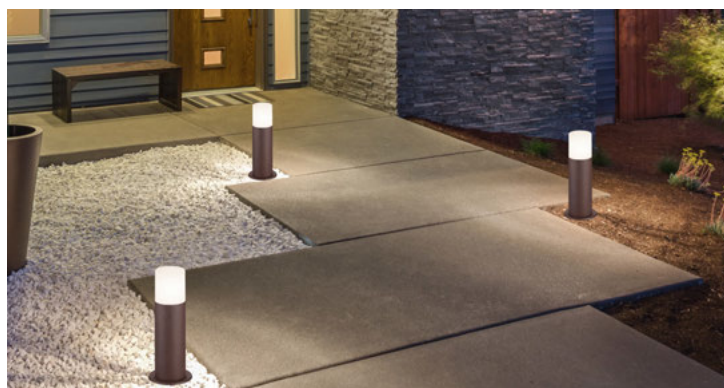



HUDSON

Aluminium Druckguss, Kunststoff
 diecast aluminium, plastic
 fonte d'aluminium, plastique
 gegoten aluminium, kunststof
 aluminio fundido, plástico
 pressofusione di alluminio, plastica
 fonta aluminiu, plastic
 valualumiini, muov
 barwione aluminium, plastik

42 Anthrazit · anthracite

Incl. 1 x LED E14, 4 W
 320 lm, 3.000 K

220060142

420060142

520060142

Incl. 2 x LED E14, 4 W
 2 x 320 lm, 3.000 K

220060242

IP44



220060142



220060242



520060142



420060142

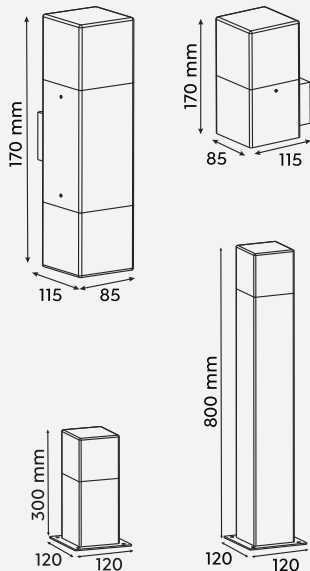

Incl. LED E14, 3,5 W
 320 lm, 3.000 K



983-40

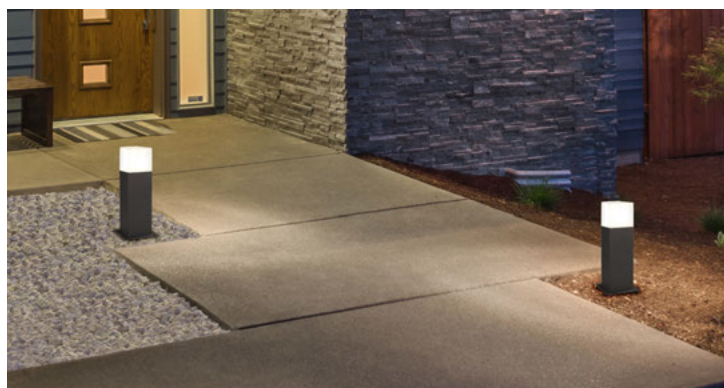



CUBANGO

Aluminium Druckguss, Kunststoff
diecast aluminium, plastic
fonte d'aluminium, plastique
gegoten aluminium, kunststof
aluminio fundido, plástico
pressofusione di alluminio, plastica
fonta aluminiu, plastic
valualumiini, muov
barwione aluminium, plastik

42 Anthrazit · anthracite

Incl. 1 x LED E27, 4,9 W
470 lm, 3.000 K

221560142

Incl. 2 x LED E27, 4,9 W
470 lm, 3.000 K

421560242

IP54

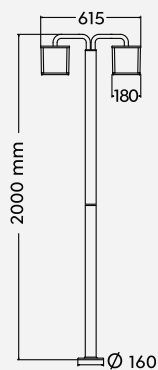
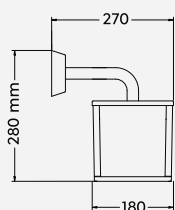

221560142



421560242

Incl. LED E27, 4,9 W
470 lm, 3.000 K



986-60



CAVADO

Aluminium Druckguss, Kunststoff
 diecast aluminium, plastic
 fonte d'aluminium, plastique
 gegoten aluminium, kunststof
 aluminio fundido, plástico
 pressofusione di alluminio, plastica
 fonta aluminiu, plastic
 valualumiini, muovi
 barwione aluminium, plastik

42 Anthrazit · anthracite

Excl. 1 x E27, max. 40 W

211069142



Excl. 1 x E27, max. 40 W

211060142

411060142

Excl. 3 x E27, max. 40 W

411060342

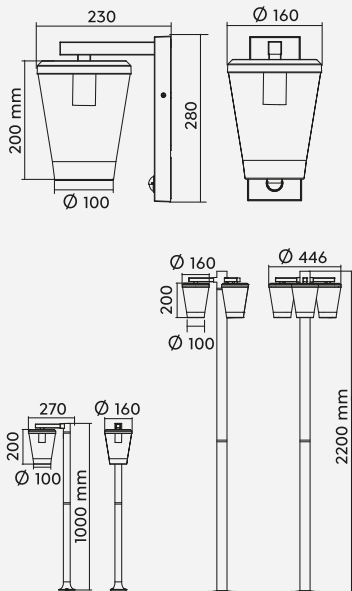

211069142



211060142



411060142



411060342

Empfohlen:
 recommended:

Filament LED
 E27, 4 W
 470 lm, 2.700 K

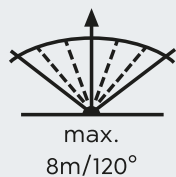



SAMBESI

Aluminium Druckguss, Acryl
diecast aluminium, acryl
fonte d'aluminium, acryl
gegoten aluminium, acryl
aluminio fundido, acrílico
pressofusione di alluminio, acrilico
fonta aluminiu, acrilic
valualumiini, akryyli
barwione aluminium, akryl

31 Weiß matt · white mat

42 Anthrazit · anthracite

Excl. 1 x E27, max. 28 W

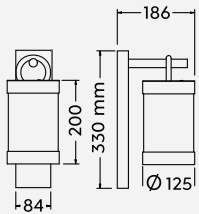

204160131



204160142

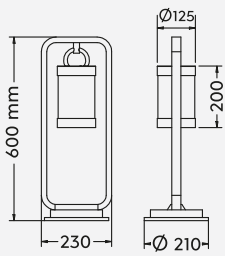

504160142

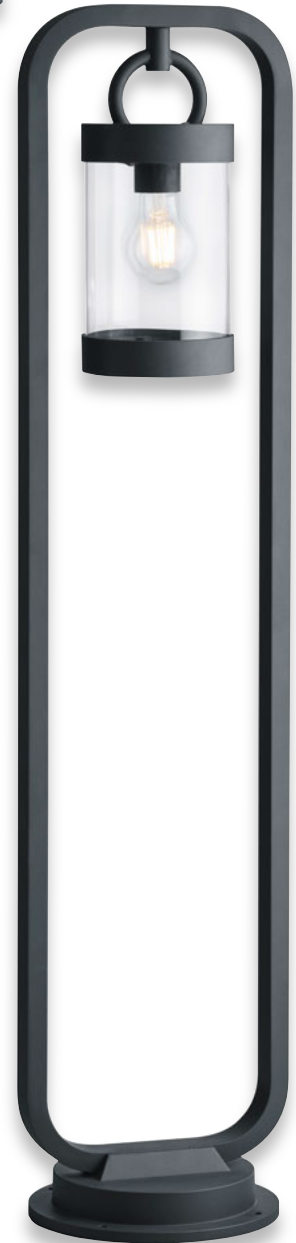
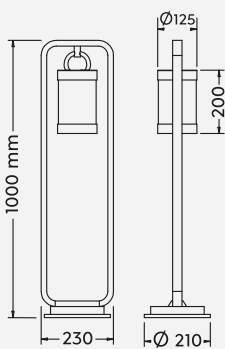

404160142

Empfohlen:
recommended:

Filament LED
E27, 4 W
470 lm, 2.700 K



987-400



Dämmerungssensor per Schalter deaktivierbar

On and off switchable dusk sensor

Détecteur de crépuscule commutable

Aan en uit schakelbare schemeringsensor

Sensor de oscuridad conmutable on/off

Sensore crepuscolare commutabile on/off

senzor de lumina/amurg on/off

On/off kytkettävä hämärätunnistin

Czujnik zmierzchowy dezaktywowany przez przełącznika

Aç-kapa anahtarlı karanlık sensörü



SAMBESI

Aluminium Druckguss, Acryl
diecast aluminium, acryl
fonte d'aluminium, acryl
gegoten aluminium, acryl
aluminio fundido, acrílico
pressofusione di alluminio, acrilico
fonta aluminiu, acrilic
valualumiini, akryyli
barwione aluminium, akryl

24 rostfarbig · rusty

Excl. 1 x E27, max. 28 W



204160124

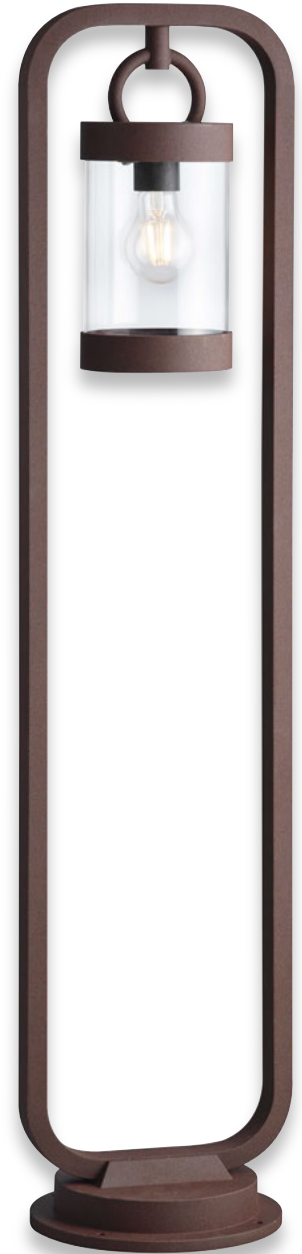

404160124



504160124

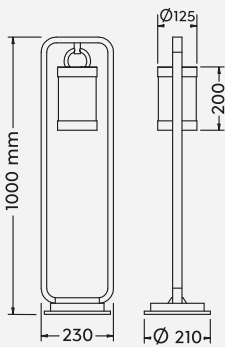
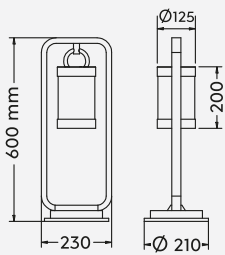
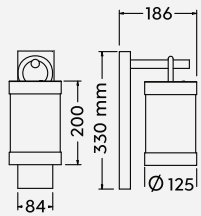

Empfohlen:
recommended:

Filament LED
E27, 4 W
470 lm, 2.700 K



987-400



Dämmerungssensor per Schalter deaktivierbar

On and off switchable dusk sensor

Décteur de crépuscule commutable

Aan en uit schakelbare schemeringsensor

Sensor de oscuridad conmutable on/off

Sensore crepuscolare commutabile on/off

senzor de lumina/amurg on/off

On/off kytkettävä hämärätunnistin

Czujnik zmierzchowy dezaktywowany przez przełącznika

Aç-kapa anahtarlı karanlık sensörü

SAMBESI

Aluminium Druckguss, Kunststoff
 diecast aluminium, plastic
 fonte d'aluminium, plastique
 gegoten aluminium, kunststof
 aluminio fundido, plástico
 pressofusione di alluminio, plastica
 fonta aluminiu, plastic
 valualumiini, muovi
 barwione aluminium, plastik

24 rostfarbig · rusty

31 Weiß matt · white mat

42 Anthrazit · anthracite

Excl. 1 x E27, max. 28 W

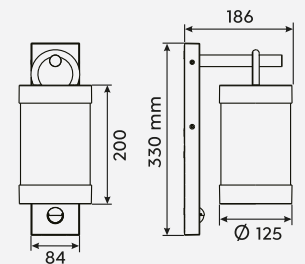

204169142



204169131



Bewegungssensor
 Motion sensor
 Détecteur de mouvement
 Bewegungssensor
 Sensor de movimiento
 Sensore di movimento
 Senzor de mişcare
 Liiketunnistin
 Czujnik ruchu

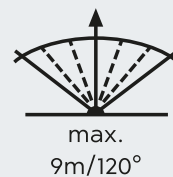

204169124

LUNGA

Aluminium Druckguss, Glas
diecast aluminium, glass
fonte d'aluminium, verre
gegoten aluminium, glas
aluminio fundido, vidrio
pressofusione di alluminio, vetro
fonta aluminiu, sticla
valualumiini, lasi
barwione aluminium, szkło

42 Anthrazit · anthracite

Excl. 1 x E27, max. 40 W

212060142



Excl. 1 x E27, max. 40 W

212069142



212060142



212069142

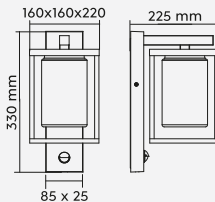
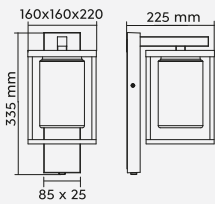

Empfohlen:
recommended:

Filament LED
E27, 4 W
470 lm, 2.700 K



987-400



Dämmerungssensor per Schalter deaktivierbar

On and off switchable dusk sensor

Détecteur de crépuscule commutable

Aan en uit schakelbare schemeringsensor

Sensor de oscuridad conmutable on/off

Sensore crepuscolare commutabile on/off

senzor de lumina/amurg on/off

On/off kytkettävä hämärätunnistin

Czujnik zmierzchowy dezaktywowany przez przełącznika

Aç-kapa anahtarlı karanlık sensörü





Bewegungssensor
Motion sensor
Détecteur de mouvement
Bewegingssensor
Sensor de movimiento
Sensore di movimento
Senzor de mișcare
Liiketunnistin
Czujnik ruchu

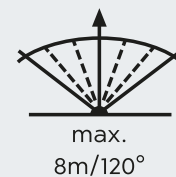

NORMAN

Aluminium Druckguss, Acryl
diecast aluminium, acryl
fonte d'aluminium, acryl
gegoten aluminium, acryl
aluminio fundido, acrílico
pressofusione di alluminio, acrilico
fonta aluminiu, acrilic
valualumiini, akryyli
barwione aluminium, akryl

24 rostfarbig · rusty

42 Anthrazit · anthracite

Excl. 1 x E27, max. 40 W



IP44

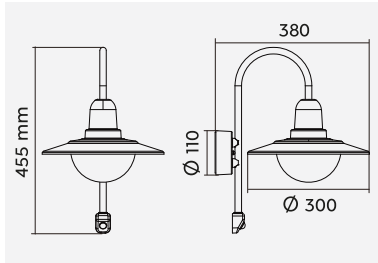

207269142



207269124

Empfohlen:
recommended:

LED E27, 4,9 W
470 lm, 3.000 K

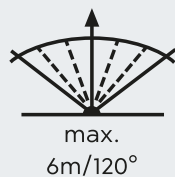

Bewegungssensor
Motion sensor
Détecteur de mouvement
Bewegungssensor
Sensor de movimiento
Sensore di movimento
Senzor de mişcare
Liiketunnistin
Czujnik ruchu

BRENTA

Aluminium Druckguss, Glas
diecast aluminium, glass
fonte d'aluminium, verre
gegoten aluminium, glas
aluminio fundido, vidrio
pressofusione di alluminio, vetro
fonta aluminiu, sticla
valualumiini, lasi
barwione aluminium, szkło

24 rostfarbig · rusty

42 Anthrazit · anthracite

Excl. 1 x E27, max. 40 W



IP44

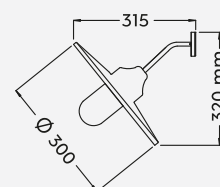

201760124



201760142



Empfohlen:
recommended:

Filament LED
E27, 4 W
470 lm, 2.700 K



987-400

OLONA

Aluminium Druckguss, Glas
diecast aluminium, glass
fonte d'aluminium, verre
gegoten aluminium, glas
aluminio fundido, vidrio
pressofusione di alluminio, vetro
fonta aluminiu, sticla
valualumiini, lasi
barwione aluminium, szkło

24 rostfarbig · rusty

42 Anthrazit · anthracite

Excl. 1 x E27, max. 40 W



IP23

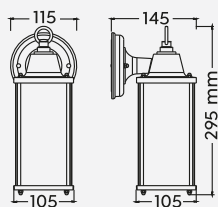

201960142

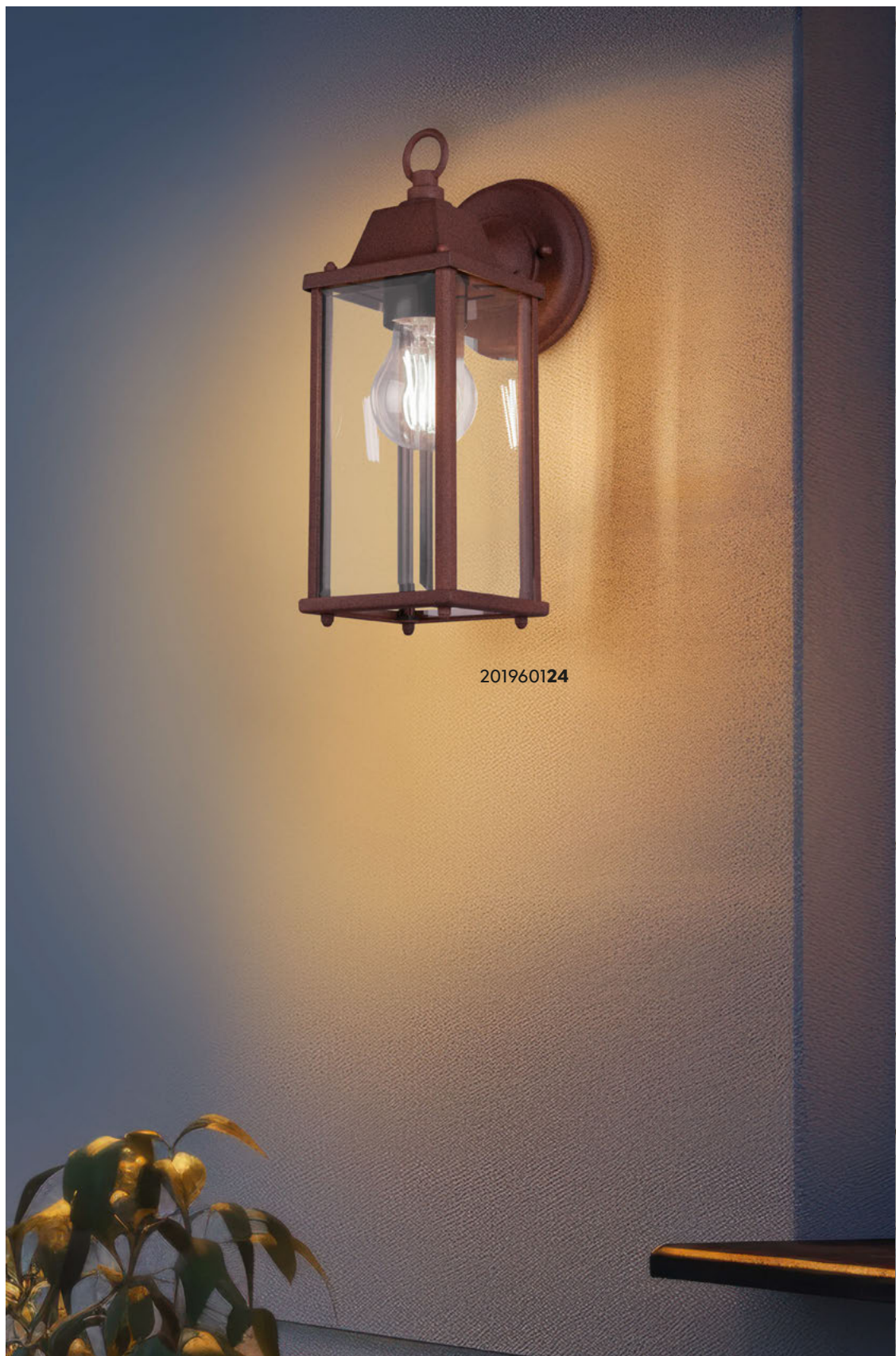

201960124

Empfohlen:
recommended:

Filament LED
E27, 4 W
470 lm, 2.700 K



987-400



TANARO

Aluminium Druckguss, Acryl
diecast aluminium, acryl
fonte d'aluminium, acryl
gegoten aluminium, acryl
aluminio fundido, acrílico
pressofusione di alluminio, acrilico
fonta aluminiu, acrilic
valualumiini, akryyli
barwione aluminium, akryl

24 rostfarbig · rusty

42 Anthrazit · anthracite

Excl. 1 x E27, max. 40 W



IP44

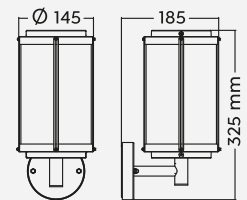

202360142



202360124



Empfohlen:
recommended:

Filament LED
E27, 4 W
470 lm, 2.700 K



987-400

DUERO

Aluminium Druckguss, Glas
diecast aluminium, glass
fonte d'aluminium, verre
gegoten aluminium, glas
aluminio fundido, vidrio
pressofusione di alluminio, vetro
fonta aluminiu, sticla
valualumiini, lasi
barwione aluminium, szkło

24 rostfarbig · rusty

42 Anthrazit · anthracite

Excl. 1 x E27, max. 40 W



IP44

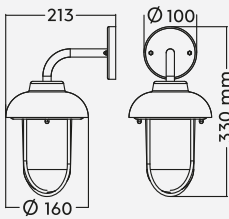

202760124



202760142

Empfohlen:
recommended:

Filament LED
E27, 4 W
470 lm, 2.700 K



987-400



TUELA

Aluminium Druckguss, Glas
diecast aluminium, glass
fonte d'aluminium, verre
gegoten aluminium, glas
aluminio fundido, vidrio
pressofusione di alluminio, vetro
fonta aluminiu, sticla
valualumiini, lasi
barwione aluminium, szkło

42 Anthrazit · anthracite

Excl. 1 x E27, max. 40 W

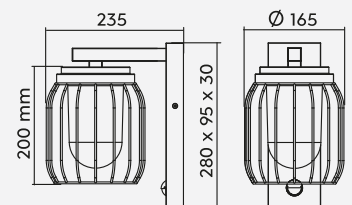

210869142



210860142



Bewegungssensor
Motion sensor
Détecteur de mouvement
Bewegungssensor
Sensor de movimiento
Sensore di movimento
Senzor de mişcare
Liiketunnistin
Czujnik ruchu

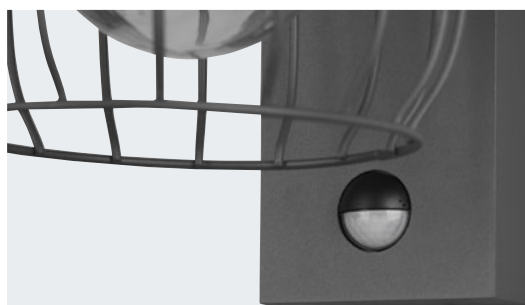

max.
8m/120°

VOLTURNO

Aluminium Druckguss, Glas
diecast aluminium, glass
fonte d'aluminium, verre
gegoten aluminium, glas
aluminio fundido, vidrio
pressofusione di alluminio, vetro
fonta aluminiu, sticla
valualumiini, lasi
barwione aluminium, szkło

28 rostfarbig antik · antique rust

Excl. 1 x E27, max. 40 W

205960128

205967128

405960128

505960128

Excl. 3 x E27, max. 60 W

405960328



IP44



205967128



205960128



405960128



505960128



405960328

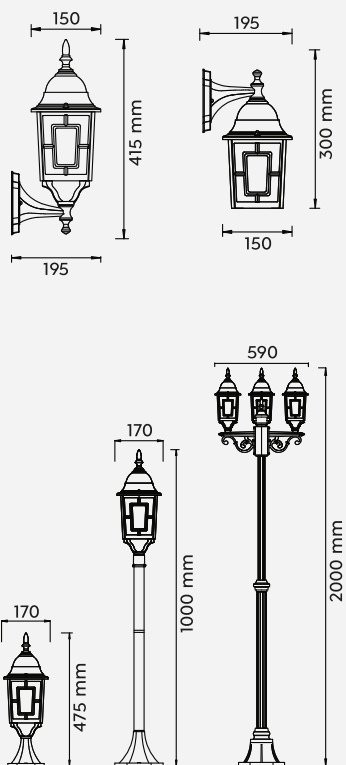

Empfohlen:
recommended:

Filament LED
E27, 4 W
470 lm, 2.700 K



987-400

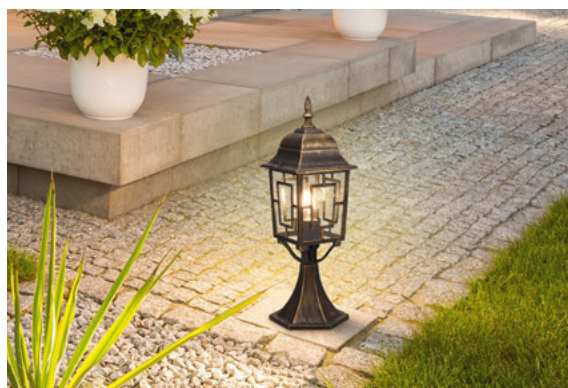



LIVENZA

Aluminium Druckguss, Glas
 diecast aluminium, glass
 fonte d'aluminium, verre
 gegoten aluminium, glas
 aluminio fundido, vidrio
 pressofusione di alluminio, vetro
 fonta aluminiu, sticla
 valualumiini, lasi
 barwione aluminium, szkło

32 Schwarz matt · black mat

Excl. 1 x E27, max. 40 W

205760132

205767132

405760132

505760132

Excl. 3 x E27, max. 40 W

405760332

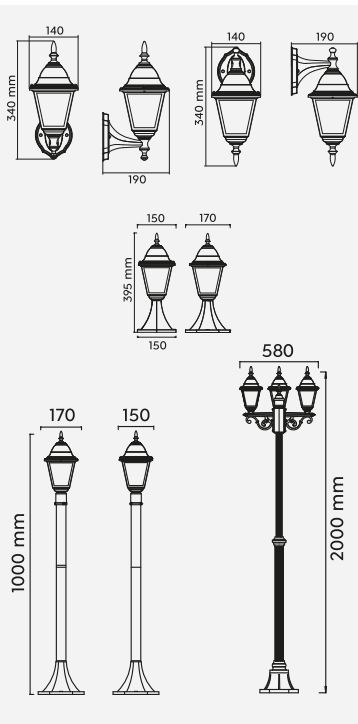

205767132



205760132



405760132



505760132



405760332

Empfohlen:
 recommended:

Filament LED
 E27, 4 W
 470 lm, 2.700 K



987-400





ELVO

Aluminium Druckguss, Glas
 diecast aluminium, glass
 fonte d'aluminium, verre
 gegoten aluminium, glas
 aluminio fundido, vidrio
 pressofusione di alluminio, vetro
 fonta aluminiu, sticla
 valualumiini, lasi
 barwione aluminium, szkło

32 Schwarz matt · black mat

Excl. 1 x E27, max. 40 W

206960132

206967132

406960132

506960132

Excl. 3 x E27, max. 40 W

406960332



IP44

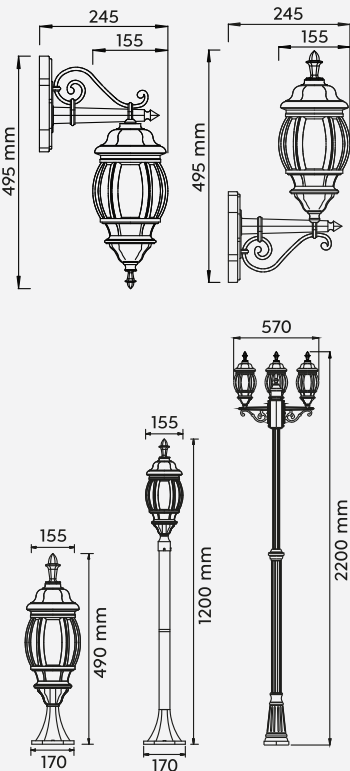

206960132



206967132



406960332



406960132



506960132

Empfohlen:
 recommended:

Filament LED
 E27, 4 W
 470 lm, 2.700 K



987-400





UBANGI

Aluminium Druckguss
diecast aluminium
fonte d'aluminium
gegoten aluminium
aluminio fundido
pressofusione di alluminio
fonta aluminii
valualumiini
barwione aluminium

42 Anthrazit · anthracite

Excl. 1 x GU10, max. 28 W

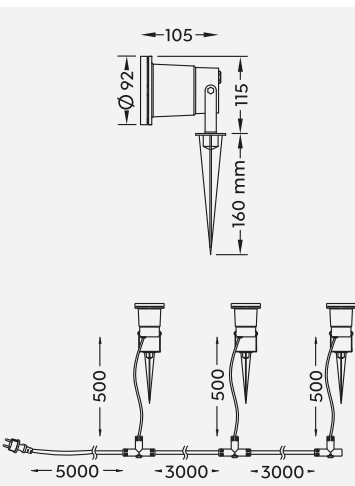

Empfohlen:
recommended:

LED GU10, 5 W
400 lm, 3.000 K
≥ 110°



955-50



800260342
3er Set / Set 3

MAREB

Aluminium Druckguss
diecast aluminium
fonte d'aluminium
gegoten aluminium
aluminio fundido
pressofusione di alluminio
fonta aluminiu
valualumiini
barwione aluminium

42 Anthrazit · anthracite

Incl. 1 x SMD-LED, 11 W
1.000 lm, 3.000 K

IP65

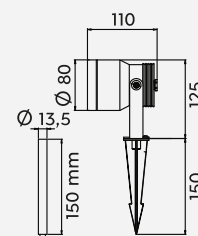

821860142

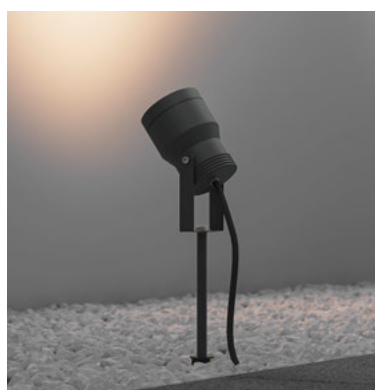

BELAJA

Bodeneinbaustrahler
Recessed floor lamps
Luminaires encastrés de sol
grond inbouwspot
Lámparas de pie empotradas
Incasso Calpestabili
Lampi incastrate in podea
upotetut maavalot
wpuszczane lampy podłogowe

07 Nickel matt · nickel mat

Incl. SMD-LED, 3,5 W
350 lm, 3.000 K

821660107

Incl. SMD-LED, 8 W
900 lm, 3.000 K

821660207

IP65

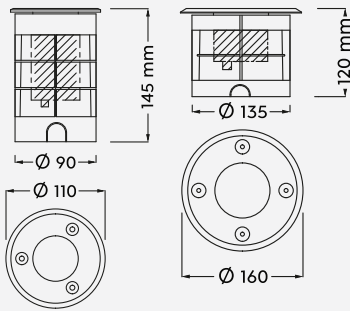

821660107



821660207



Abstrahlwinkel
Emission angle
Angle de rayonnement
Uitstraalhoek
Ángulo de emisión
Angolo di emissione
Unghiul de emisii
Säteilykulma
Kät emisiji



Belastbarkeit
Resilience
Limite de charge
Belastbaarheid
Resistencia
Resistenza
Rezistența la solicitare
Kuormitettavuus
Nośność



GARTENSTECKDOSEN · GARDEN SOCKETS



9964-42

Aluminium Druckguss
diecast aluminium
fonte d'aluminium
gegooten aluminium
aluminio fundido
pressofusione di alluminio
fonta aluminiu
valualumiini
barwione aluminium

42 Anthrazit · anthracite

max. 3.600 W

IP44  x 4

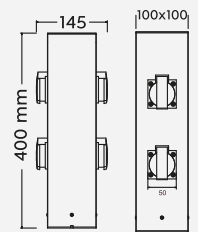

9962-11

Polyresin
polyresin
polyresin
polyresin
poliresina
poliestere
polirasina
polyresiini
polyresin

11 Grau · grey

max. 3.600 W

9962-11

IP44   x 4

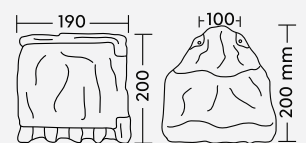

 x 4



UNIVERSAL-ERDSPIESS · GROUND SPIKE

Erdspieß, Edelstahl
Ground spike, steel
Piquet de terre, acier
Aardingspin, staal
Espiga, acero
Picchetto, acciaio
Țepușă pentru pământ, inox
Maapiikki, teräs
Žerdz, stal

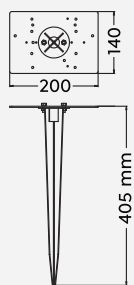

9960-07

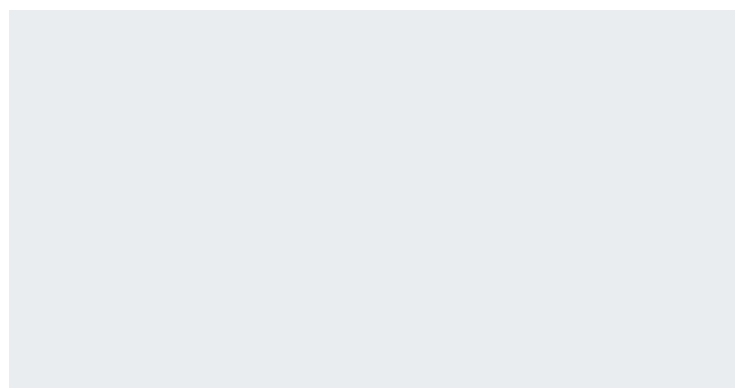

ECKBEFESTIGUNG · CORNER FASTENING

Eckbefestigung, Kunststoff
Corner fastening, plastic
Montage en angle, plastique
Hoekbevestiging, kunststof
Cantонера, plástico
Montaggio ad angolo, plastica
Fixare pentru colț, plastic
Kulmakiinnike, muovi
Okucie narożne, plastik

32 Schwarz matt · black mat



9965-32

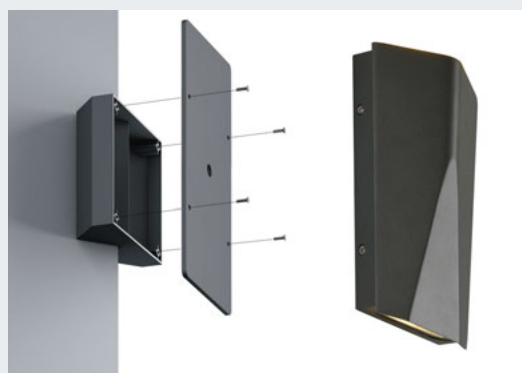
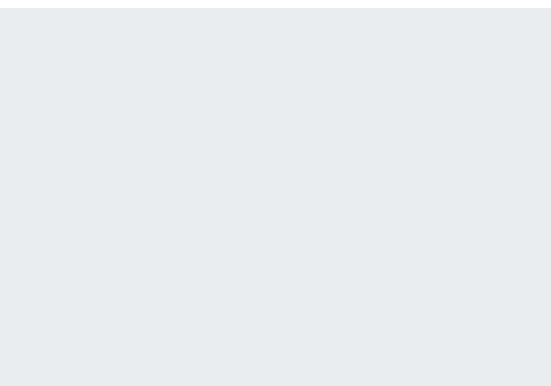
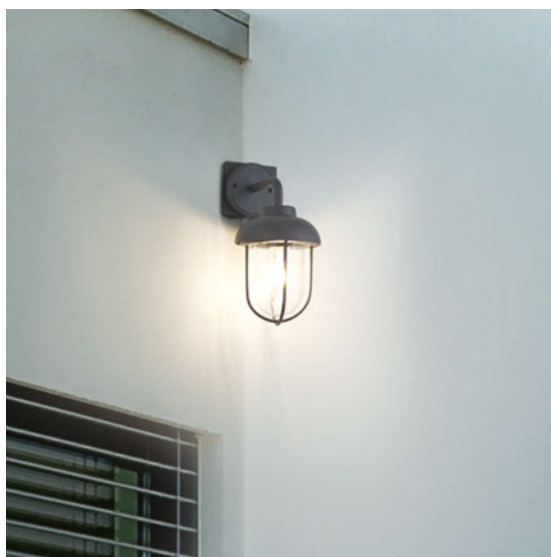
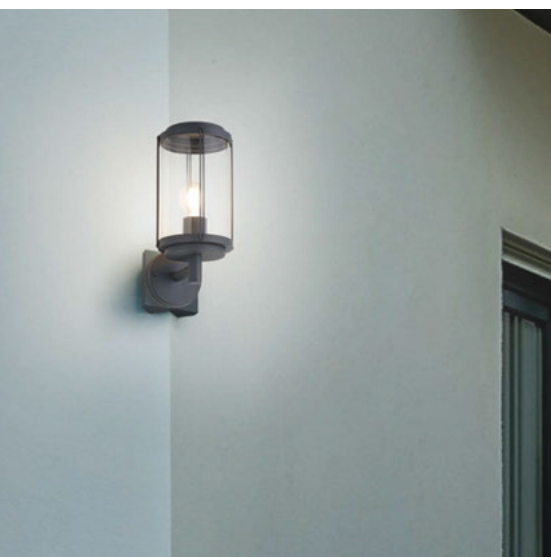
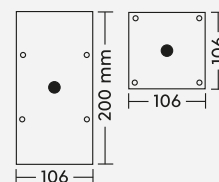

RL
live your light





PALOMA

Metall, Kunststoff
 metal, plastic
 metale, plastique
 metaal, kunststof
 metal, plástico
 metallo, plastica
 metal, plastic
 metalli, muovi
 metal, plastik

42 Anthrazit · anthracite

Excl. 1 x E27, max. 28 W



R21719142



R41719142



R51719142

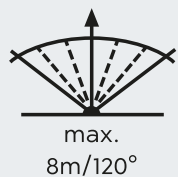
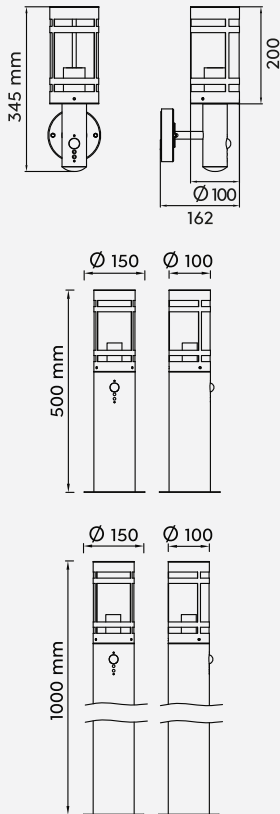

Bewegungssensor
 Motion sensor
 Détecteur de mouvement
 Bewegungssensor
 Sensor de movimiento
 Sensore di movimento
 Senzor de mişcare
 Liiketunnistin
 Czujnik ruchu





PALOMA

Metall, Kunststoff
 metal, plastic
 metallo, plastica
 metaal, kunststof
 metal, plástico
 metallo, plastica
 metal, plastic
 metalli, muovi
 metal, plastik

42 Anthrazit · anthracite

Excl. 1 x E27, max. 28 W



IP44



R21716142



R41716142



R51716142

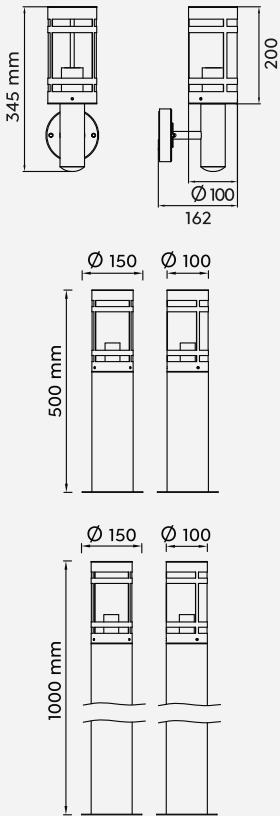

Empfohlen:
 recommended:

Filament LED
 E27, 4 W
 470 lm, 2.700 K



987-400





BONITO

Aluminium Druckguss, Kunststoff
 diecast aluminium, plastic
 fonte d'aluminium, plastique
 gegoten aluminium, kunststof
 aluminio fundido, plástico
 pressofusione di alluminio, plastica
 fonta aluminiu, plastic
 valualumiini, muov
 barwione aluminium, plastik

- 24** rostfarbig · rusty
- 31** Weiß matt · white mat
- 32** Schwarz matt · black mat

Excl. 1 x E27, max. 28 W

- R21596124**
- R21596131**
- R21596132**



Excl. 1 x E27, max. 28 W

- R21599124**
- R21599131**
- R21599132**

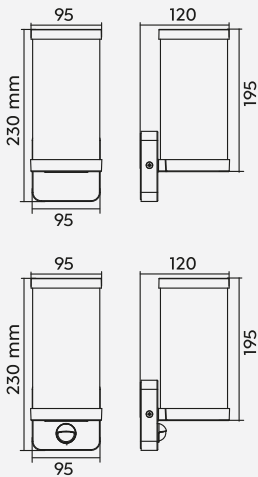

R21596124



R21596131



R21596132



R21599131



R21599132



R21599124

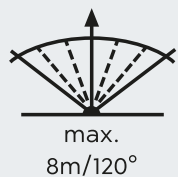

Bewegungssensor
 Motion sensor
 Détecteur de mouvement
 Bewegungssensor
 Sensor de movimiento
 Sensore di movimento
 Senzor de mişcare
 Liiketunnistin
 Czujnik ruchu





CORDOBA

Kunststoff
plastic
plastique
kunststof
plástico
plastica
plastic
muovi
plastik

31 Weiß matt · white mat

32 Schwarz matt · black mat

Incl. 2 x SMD-LED, 2 W
2 x 200 lm, 3.000 K



R28222631

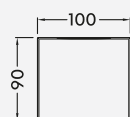
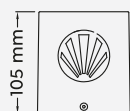

R28222632



ROSARIO



R28232631

Kunststoff
plastic
plastique
kunststof
plástico
plastica
plastic
muovi
plastik

- 31** Weiß matt · white mat
- 32** Schwarz matt · black mat

Incl. 2 x SMD-LED, 2 W
2 x 200 lm, 3.000 K

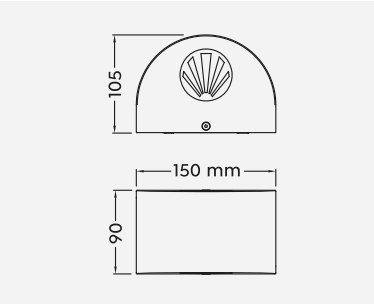

R28232632

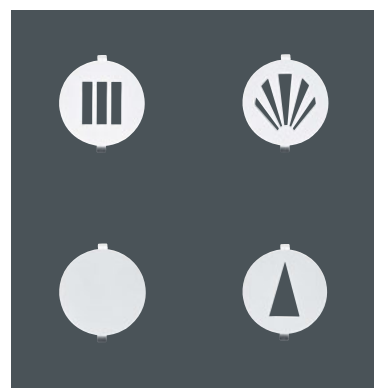

MOLINA

Aluminium Druckguss, Kunststoff
diecast aluminium, plastic
fonte d'aluminium, plastique
gegoten aluminium, kunststof
aluminio fundido, plástico
pressofusione di alluminio, plastica
fonta aluminiu, plastic
valualumiini, muovi
barwione aluminium, plastik

42 Anthrazit · anthracite

Incl. 2 x SMD-LED, 4,6 W
2 x 550 lm, 3.000 K

IP54

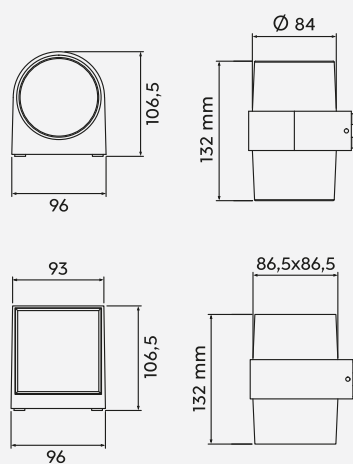

R22052142



R22062142

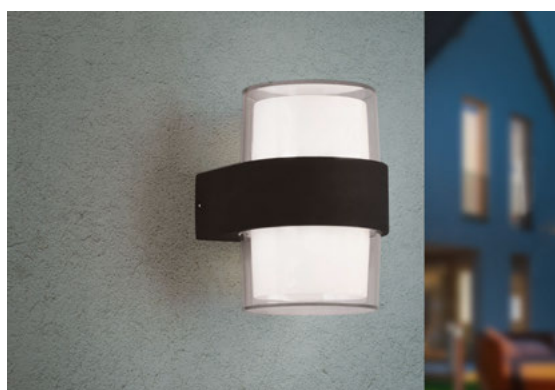

LIMEIRA

Kunststoff
plastic
plastique
kunststof
plástico
plastica
plastic
muovi
plastik

32 Schwarz matt · black mat

Incl. 2 x SMD-LED, 3,5 W
2 x 380 lm, 3.000 K

IP44

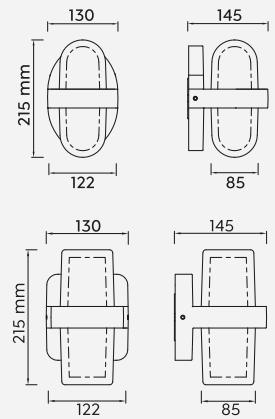

R24256232



R24266232



PUNO

Kunststoff
plastic
plastique
kunststof
plástico
plastica
plastic
muovi
plastik

32 Schwarz matt · black mat

Incl. SMD-LED, 8 W
800 lm, 3.000 K

IP54

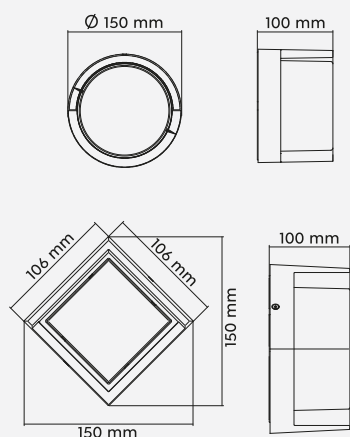

R27036132

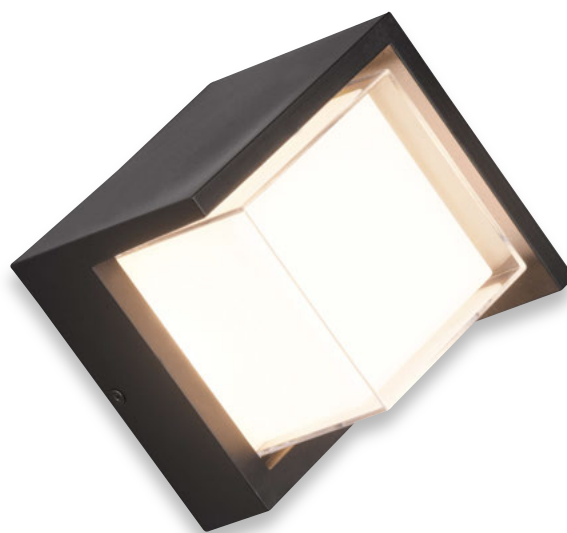

R27026132





PUELO

Aluminium Druckguss, Kunststoff
diecast aluminium, plastic
fonte d'aluminium, plastique
gegoten aluminium, kunststof
aluminio fundido, plástico
pressofusione di alluminio, plastica
fonta aluminiu, plastic
valualumiini, muovi
barwione aluminium, plastik

31 Weiß matt · white mat

32 Schwarz matt · black mat

Excl. 1 x E27, max. 10 W



IP44

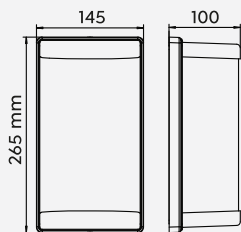

R21186132



R21186131



Empfohlen:
recommended:

LED E27, 4,9 W
470 lm, 3.000 K



987-60



CALERA

Aluminium Druckguss, Kunststoff
diecast aluminium, plastic
fonte d'aluminium, plastique
gegoten aluminium, kunststof
aluminio fundido, plástico
pressofusione di alluminio, plastica
fonta aluminiu, plastic
valualumiini, muovi
barwione aluminium, plastik

32 Schwarz matt · black mat

Incl. 1 x SMD-LED, 8 W
800 lm, 3.000 K

IP54

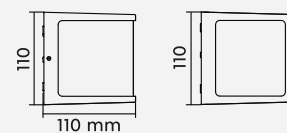

R27446132

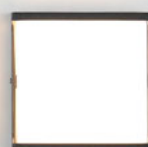

VENADO

Kunststoff
plastic
plastique
kunststof
plástico
plastica
plastic
muovi
plastik

42 Anthrazit · anthracite

Incl. 1 x SMD-LED, 9,5 W
1.000 lm, 3.000 K

IP54

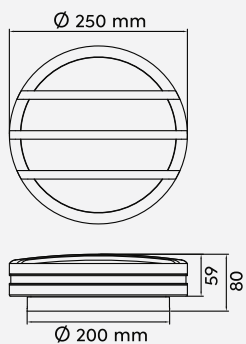

R24236142



MORENA

Kunststoff
plastic
plastique
kunststof
plástico
plastica
plastic
muovi
plastik

32 Schwarz matt · black mat

Incl. 1 x SMD-LED, 14 W
1.500 lm, 2.300 + 3.000 + 4.000 K

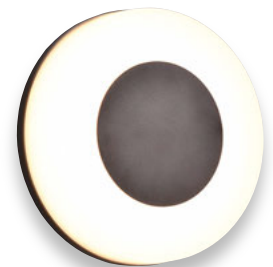
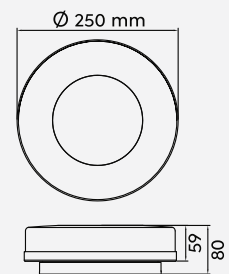

R24246132



DIP SWITCH

Lichtfarben direkt an der Leuchte einstellbar

Colours directly adjustable at the lamp

Les couleurs de la lumière peuvent être réglées directement sur le luminaire

Lichtkleuren direct instelbaar op de lamp

Tonalidades de luz ajustables directamente en la lámpara

Colori della luce regolabili direttamente sulla lampada

Colori ale luminii reglabile direct de la bec

Valon väri asetettävissa suoraan valaisimesta

Barwy światła można ustawić bezpośrednio na oprawie

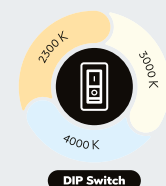

CAMARO

Kunststoff
 plastic
 plastique
 kunststof
 plástico
 plastica
 plastic
 muovi
 plastik

31 Weiß matt · white mat

42 Anthrazit · anthracite

Excl. 1 x E27, max. 12 W

R60501031

R60501042

Excl. 2 x E27, max. 12 W

R60502031

R60502042



IP54



R60501031



R60501042



R60502031



R60502042

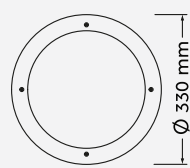
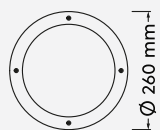

Empfohlen:
 recommended:

LED E27, 4 W
 320 lm, 3.000 K



986-60



KENDAL

Kunststoff
plastic
plastique
kunststof
plástico
plastica
plastic
muovi
plastik

42 Anthrazit · anthracite

Incl. SMD-LED, 11 W
1.180 lm, 3.000 K

R62151142

Incl. SMD-LED, 12 W
1.400 lm, 3.000 K

R22151142

IP54

R22151142

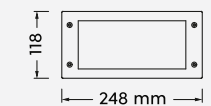
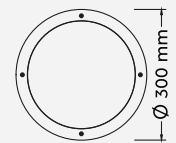

R62151142

