

901114 AMANDOLO

ceiling light; aluminium, steel, white / plastic, white
 Deckenleuchte; Alu, Stahl, weiss / Kunststoff, weiss
 plafonnier; aluminium, acier, blanc / plastique, blanc

L 400, B 300, H 65



901116 AMANDOLO

ceiling light; aluminium, steel, white / plastic, white
 Deckenleuchte; Alu, Stahl, weiss / Kunststoff, weiss
 plafonnier; aluminium, acier, blanc / plastique, blanc

L 400, B 200, H 65



901113 AMANDOLO

ceiling light; aluminium, steel, black / plastic, white
 Deckenleuchte; Alu, Stahl, schwarz / Kunststoff, weiss
 plafonnier; aluminium, acier, noir / plastique, blanc

L 400, B 300, H 65

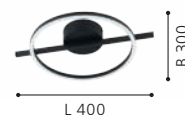
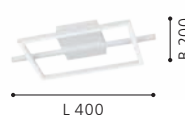
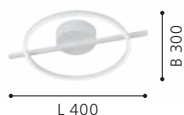



901115

LED

incl./inkl./inclus



901115 AMANDOLO

ceiling light; aluminium, steel, black / plastic, white
Deckenleuchte; Alu, Stahl, schwarz / Kunststoff, weiss
plafonnier; aluminium, acier, noir / plastique, blanc

L 400, B 200, H 65

LED

17W

RGB+TW

1900lm



Remote



9 008606 303939

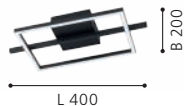



900952

LED



incl./inkl./inclus

REMOTE+

Our new 2.4 GHz REMOTE+ makes it easier than ever to control your luminaires. With its user-friendly design and simple control, you can easily adjust your luminaires to create the perfect ambiance for any occasion:

- > Stepless Dimming
- > Quick Pairing
- > Timer Function
- > Stepless Tunable White
- > Memory Effect
- > Control up to 10 REMOTE+ luminaires

Unsere neue 2,4-GHz REMOTE+ macht die Steuerung Ihrer Leuchten so einfach wie nie zuvor. Mit ihrem benutzerfreundlichen Design und der einfachen Steuerung können Sie Ihre Leuchten ganz einfach einstellen, um das perfekte Ambiente für jede Gelegenheit zu schaffen:

- > Stufenloses Dimmen
- > Schnelle Kopplung
- > Timer-Funktion
- > Stufenlos einstellbares Weiß
- > Memory-Effekt
- > Steuerung von bis zu 10 REMOTE+-Leuchten

Notre nouvelle REMOTE+ 2,4 GHz facilite plus que jamais le contrôle de vos lumières. Grâce à sa conception conviviale et à sa commande simple, vous pouvez facilement régler votre luminaires pour créer l'ambiance parfaite en toute occasion:

- > Gradation progressive
- > appairage rapide
- > Fonction de minuterie
- > Blanc réglable en continu
- > Effet de mémoire
- > Contrôle jusqu'à 10 luminaires REMOTE

900952 AMANDOLO

ceiling light; aluminium, steel, white / plastic, white
 Deckenleuchte; Alu, Stahl, weiss / Kunststoff, weiss
 plafonnier; aluminium, acier, blanc / plastique, blanc

L 775, B 200, H 75



23,5W



2850lm



Remote



9 008606 275045





900953

LED

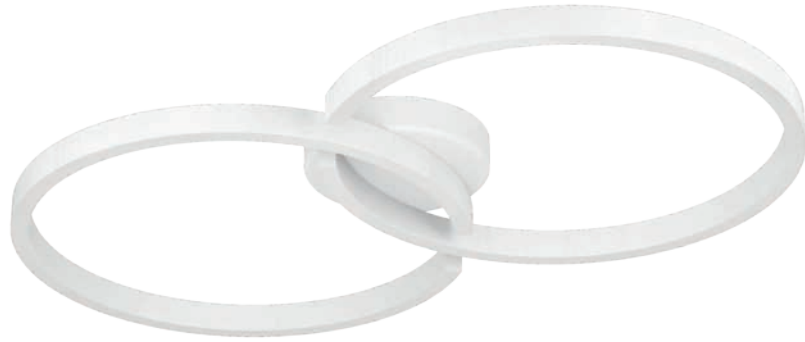

900954

LED



900955

LED



900953 AMANDOLO

ceiling light; aluminium, steel, black / plastic, white
Deckenleuchte; Alu, Stahl, schwarz / Kunststoff, weiss
plafonnier; aluminium, acier, noir / plastique, blanc

L 775, B 200, H 75



23,5 W 2850 lm

900954 AMANDOLO

ceiling light; aluminium, steel, white / plastic, white
Deckenleuchte; Alu, Stahl, weiss / Kunststoff, weiss
plafonnier; aluminium, acier, blanc / plastique, blanc

L 675, B 380, H 65



19,5 W 2400 lm

900955 AMANDOLO

ceiling light; aluminium, steel, black / plastic, white
Deckenleuchte; Alu, Stahl, schwarz / Kunststoff, weiss
plafonnier; aluminium, acier, noir / plastique, blanc

L 675, B 380, H 65



19,5 W 2400 lm



9 008606 275052



9 008606 275069



9 008606 275076





900563

LED



CARANACOA

These luminaires have swiveling light rings.
 Diese Leuchten verfügen über schwenkbare Leuchtringe.
 Ces luminaires ont des anneaux lumineux pivotants.

900563 CARANACOA

pendant light; steel, black / plastic, white
 Hängeleuchte; Stahl, schwarz / Kunststoff, weiss
 luminaire en suspension; acier, noir / plastique, blanc

L 1170, B 230, H 1100

LED

5x 7 W

warm
WHITE

7000lm



9 008606 244652

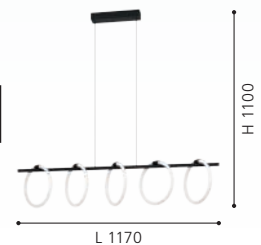



900562 CARANACOA

pendant light; steel, black / plastic, white
 Hängeleuchte; Stahl, schwarz / Kunststoff, weiss
 luminaire en suspension; acier, noir / plastique, blanc

L 780, B 230, H 1100



3x 9W 3600lm



9 008606 244645

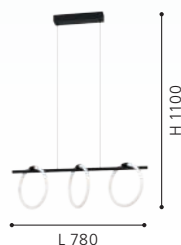

900564 CARANACOA

wall light; steel, black / plastic, white
 Wandleuchte; Stahl, schwarz / Kunststoff, weiss
 Applique; acier, noir / plastique, blanc

L 260, H 260, A 45



11,5W 1500lm



9 008606 244669



900565 CARANACOA

table light; steel, black / plastic, white
 Tischleuchte; Stahl, schwarz / Kunststoff, weiss
 luminaire de table; acier, noir / plastique, blanc

L 260, B 50, H 260, Base: Ø 100



11,5W 1500lm



9 008606 244676





99358



900631



900632



99358 CODRIALES

pendant light; steel, black / plastic, white
 Hängeleuchte; Stahl, schwarz / Kunststoff, weiss
 luminaire en suspension; acier, noir / plastique, blanc

L 780, B 300, H 1100



27W



4000lm



900631 CODRIALES

ceiling light; aluminium, black / plastic, white
 Deckenleuchte; Alu, schwarz / Kunststoff, weiss
 plafonnier; aluminium, noir / plastique, blanc

L 790, B 300, H 116



27W



4000lm



900632 CODRIALES

wall light; aluminium, black / plastic, white
 Wandleuchte; Alu, schwarz / Kunststoff, weiss
 Applique; aluminium, noir / plastique, blanc

L 180, H 320, A 65



10,8W



1400lm



9 002759 993580

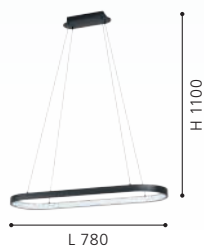

9 008606 241040



9 008606 241057





900633

LED

900633 CODRIALES

table light; aluminium, black / plastic, white

Tischleuchte; Alu, schwarz / Kunststoff, weiss

luminaire de table; aluminium, noir / plastique, blanc

L 205, B 80, H 380

LED

10,8W

warm
WHITE

1500lm



9 008606 241064

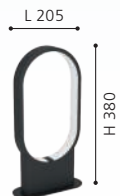



901267



901266



901268



901267 SERPINS

pendant light; aluminium, steel, black / plastic, white
 Hängeleuchte; Alu, Stahl, schwarz / Kunststoff, weiss
 luminaire en suspension; aluminium, acier, noir / plastique, blanc

L 660, B 300, H 1100



21W 2500lm



9 008606 313662

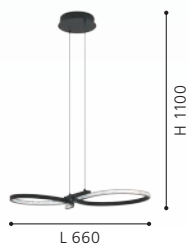

901266 SERPINS

ceiling light; aluminium, steel, black / plastic, white
 Deckenleuchte; Alu, Stahl, schwarz / Kunststoff, weiss
 plafonnier; aluminium, acier, noir / plastique, blanc

L 600, B 340, H 75



21W 2500lm



9 008606 313655

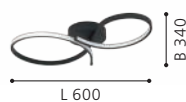

901268 SERPINS

wall light; aluminium, steel, black / plastic, white
 Wandleuchte; Alu, Stahl, schwarz / Kunststoff, weiss
 Applique; aluminium, acier, noir / plastique, blanc

L 205, H 400, A 75



11,4W 1400lm



9 008606 313679





901269

LED



901271

LED

901269 SERPINS

table light; aluminium, steel, black / plastic, white
Tischleuchte; Alu, Stahl, schwarz / Kunststoff, weiss
luminaire de table; aluminium, acier, noir / plastique, blanc

L 205, B 150, H 405



11,4W 1400lm



9 008606 313686



901271 SERPINS

floor light; aluminium, steel, black / plastic, white
Stehleuchte; Alu, Stahl, schwarz / Kunststoff, weiss
lampadaire; aluminium, acier, noir / plastique, blanc

L 425, B 250, H 1070, Base: Ø 250



20W 2500lm



9 008606 313693

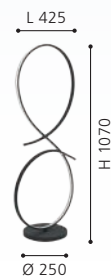



900948



900951



900948 GIANELLA

pendant light; aluminium, steel, black / plastic, white
 Hängeleuchte; Alu, Stahl, schwarz / Kunststoff, weiss
 luminaire en suspension; aluminium, acier, noir / plastique, blanc

L 1000, B 360, H 1200



38W 4400lm



9 008606 275014



900951 GIANELLA

table light; aluminium, steel, black / plastic, white
 Tischleuchte; Alu, Stahl, schwarz / Kunststoff, weiss
 luminaire de table; aluminium, acier, noir / plastique, blanc

L 215, B 140, H 395, Base: Ø 130



14,5W 1400lm



9 008606 275038

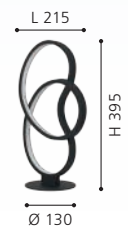



900947

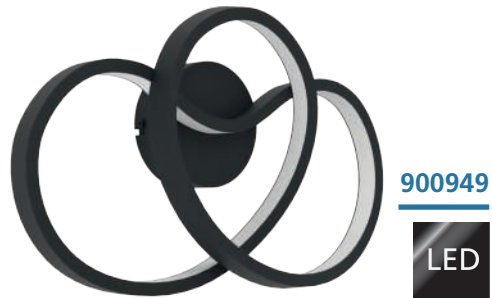

900949



901015



900947 GIANELLA

ceiling light; aluminium, steel, black / plastic, white
Deckenleuchte; Alu, Stahl, schwarz / Kunststoff, weiss
plafonnier; aluminium, acier, noir / plastique, blanc

L 880, B 300, H 80



38W 4400lm



9 008606 275007



900949 GIANELLA

wall light; aluminium, steel, black / plastic, white
Wandleuchte; Alu, Stahl, schwarz / Kunststoff, weiss
Applique; aluminium, acier, noir / plastique, blanc

L 370, H 215, A 80



14,5W 1400lm



9 008606 275021

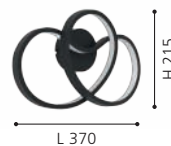

901015 GIANELLA

floor light; aluminium, steel, black / plastic, white
Stehleuchte; Alu, Stahl, schwarz / Kunststoff, weiss
lampadaire; aluminium, acier, noir / plastique, blanc

L 250, B 300, H 1205, Base: Ø 250



38W 4400lm



9 008606 291489

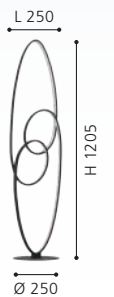



900465



900466



900465 SIBERIA

ceiling light; steel, black / plastic, white
Deckenleuchte; Stahl, schwarz / Kunststoff, weiss
plafonnier; acier, noir / plastique, blanc

L 780, B 160, H 235



34W



4600lm



Remote



900466 SIBERIA

pendant light; steel, black / plastic, white
Hängeleuchte; Stahl, schwarz / Kunststoff, weiss
luminaire en suspension; acier, noir / plastique, blanc

L 780, B 160, H 1100



34W



4500lm



Remote



900467 SIBERIA

wall light; steel, black / plastic, white
Wandleuchte; Stahl, schwarz / Kunststoff, weiss
applique; acier, noir / plastique, blanc

L 160, H 300, A 190



15,5W



2200lm



Remote



9 008606 244041



9 008606 244058

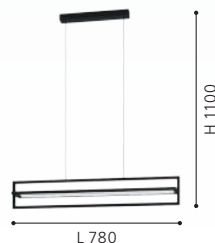

9 008606 244065





900467

LED

incl./inkl./inclus

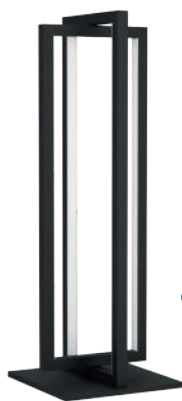

900468

LED

incl./inkl./inclus

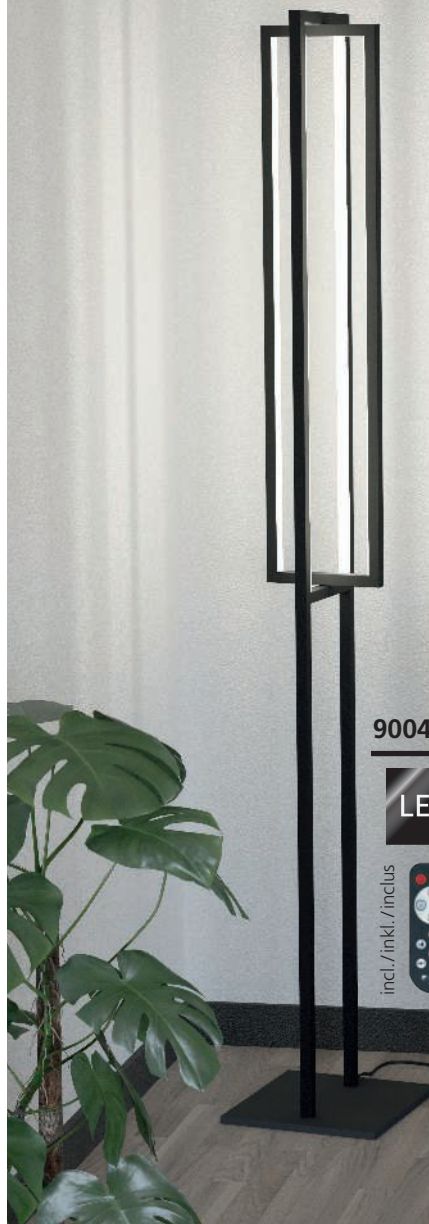

900469

LED

incl./inkl./inclus



900468 SIBERIA

table light; steel, black / plastic, white
Tischleuchte; Stahl, schwarz / Kunststoff, weiss
luminaire de table; acier, noir / plastique, blanc

L 160, B 160, H 430, Base: B 160, T 160



15,5W



2200lm



Remote



9 008606 244072

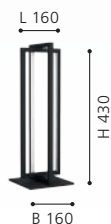

L 160

H 430

B 160

900469 SIBERIA

floor light; steel, black / plastic, white
Stehleuchte; Stahl, schwarz / Kunststoff, weiss
lampadaire; acier, noir / plastique, blanc

L 200, B 160, H 1330, Base: B 200, T 160



34W



4600lm



Remote



9 008606 244089

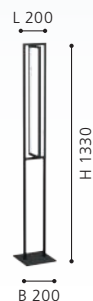

L 200

H 1330

B 200



900489 PANAGRIA

pendant light; aluminium, steel, wood, black, brown / plastic, white

Hängeleuchte; Alu, Stahl, Holz, schwarz, braun / Kunststoff, weiss

luminaire en suspension; aluminium, acier, bois, noir, marron / plastique, blanc

L 935, B 75, H 1100

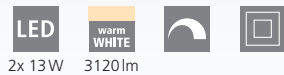

2x 13W 3120lm



9 008606 244249

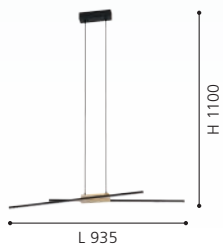

900488 PANAGRIA

ceiling light; aluminium, steel, wood, black, brown / plastic, white

Deckenleuchte; Alu, Stahl, Holz, schwarz, braun / Kunststoff, weiss

plafonnier; aluminium, acier, bois, noir, marron / plastique, blanc

L 935, B 75, H 110

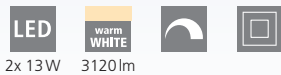

2x 13W 3120lm



9 008606 244232

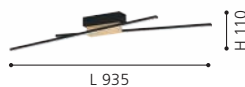

900491 PANAGRIA

wall light; aluminium, steel, wood, black, brown / plastic, white

Wandleuchte; Alu, Stahl, Holz, schwarz, braun / Kunststoff, weiss

Applique; aluminium, acier, bois, noir, marron / plastique, blanc

L 75, H 540, A 85



2x 6,3W 1510lm



9 008606 244256





900493



900492



900493 PANAGRIA

floor light; aluminium, steel, wood, black, brown / plastic, white
 Stehleuchte; Alu, Stahl, Holz, schwarz, braun / Kunststoff, weiss
 lampadaire; aluminium, acier, bois, noir, marron / plastique, blanc

L 85, B 75, H 1460, Base: B 160, T 160



1x 12,8W 2880lm 1x 11,2W



9 008606 244270



900492 PANAGRIA

table light; aluminium, steel, wood, black, brown / plastic, white
 Tischleuchte; Alu, Stahl, Holz, schwarz, braun / Kunststoff, weiss
 luminaire de table; aluminium, acier, bois, noir, marron / plastique, blanc

L 75, B 45, H 455, Base: B 100, T 100



1x 6,8W 1440lm 1x 5,2W



9 008606 244263





900175



DESIGN
HIGHLIGHT
DETAIL



900175 LISCIANA

pendant light; aluminium, steel, wood, grey / plastic, white
 Hängeleuchte; Alu, Stahl, Holz, grau / Kunststoff, weiss
 luminaire en suspension; aluminium, acier, bois, gris / plastique, blanc

L 1260, B 35, H 1100



22W



2500lm



9 008606 238088

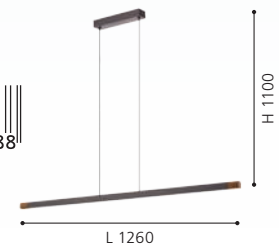

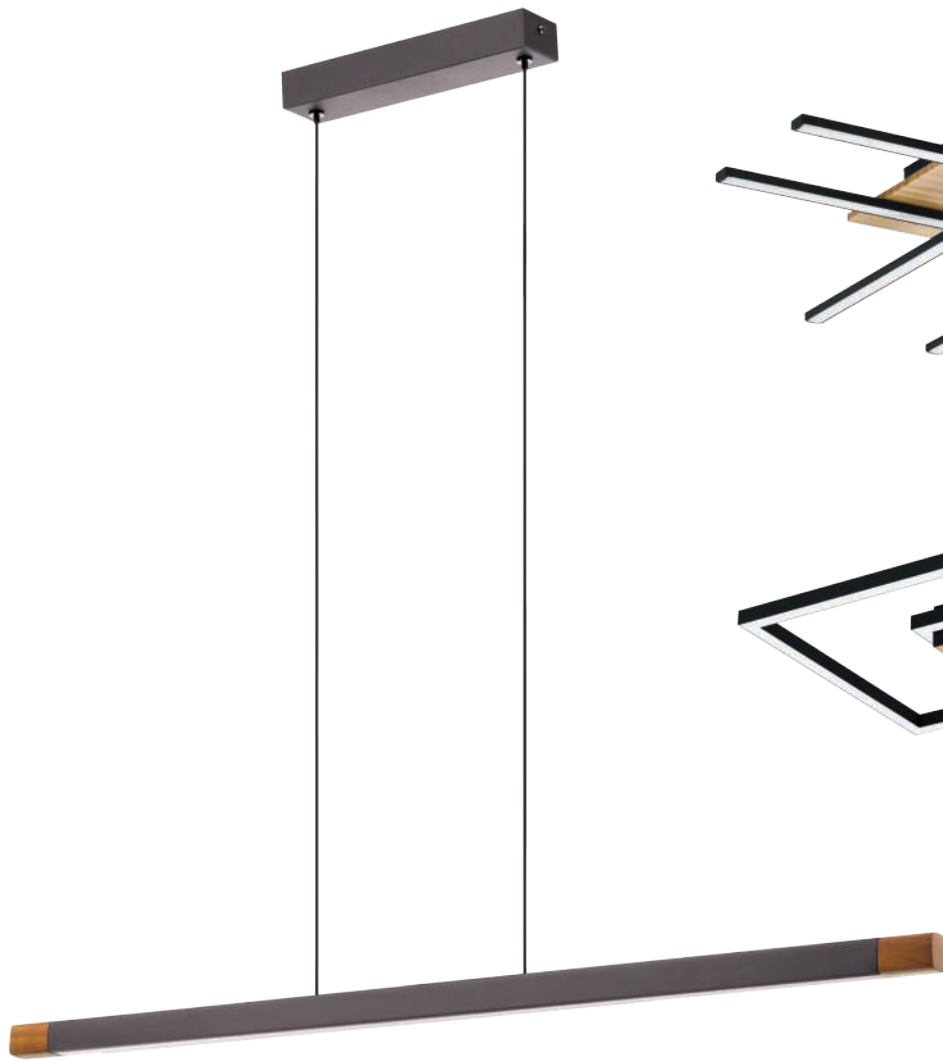

900174



99793



901742



incl./inkl./inclus



900174 LISCIANA

pendant light; aluminium, steel, wood, grey / plastic, white
 Hängeleuchte; Alu, Stahl, Holz, grau / Kunststoff, weiss
 luminaire en suspension; aluminium, acier, bois, gris / plastique, blanc

L 875, B 35, H 1100



18W 2000lm



9 008606 238071

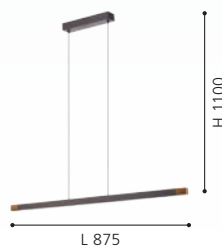

99793 MARINELLO 1

ceiling light; aluminium, steel, wood, black, brown / plastic, white
 Deckenleuchte; Alu, Stahl, Holz, schwarz, braun / Kunststoff, weiss
 plafonnier; aluminium, acier, bois, noir, marron / plastique, blanc

L 500, B 500, H 90



4x 5,3W 2800lm



9 002759 997939

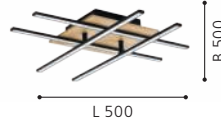

901742 MARINELLO

ceiling light; aluminium, steel, wood, black, brown / plastic, white
 Deckenleuchte; Alu, Stahl, Holz, schwarz, braun / Kunststoff, weiss
 plafonnier; aluminium, acier, bois, noir, marron / plastique, blanc

L 485, B 485, H 55



2x 17W 4400lm 4,2W 590lm



Remote



9 008606 327881





99817

LED



99817 IPOLITTO

ceiling light; aluminium, steel, black / plastic, white
Deckenleuchte; Alu, Stahl, schwarz / Kunststoff, weiss
plafonnier; aluminium, acier, noir / plastique, blanc

L 995, B 165, H 245

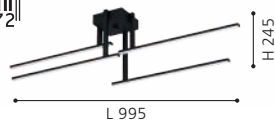

99818 SALITRE

pendant light; aluminium, black / plastic, white
Hängeleuchte; Alu, schwarz / Kunststoff, weiss
luminaire en suspension; aluminium, noir / plastique, blanc

H 1200, Ø 730

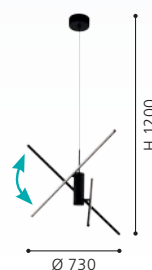

901052 MONGOLANA

floor light; aluminium, steel, black / plastic, white
Stehleuchte; Alu, Stahl, schwarz / Kunststoff, weiss
lampadaire; aluminium, acier, noir / plastique, blanc

H 1510, Base: Ø 355





900597



900596



99316



900597 PADULARI

ceiling light; aluminium, steel, black / plastic, white
Deckenleuchte; Alu, Stahl, schwarz / Kunststoff, weiss
plafonnier; aluminium, acier, noir / plastique, blanc

L 535, B 470, H 50



25,6W



3800lm



Remote

900596 ULISANO

ceiling light; aluminium, steel, black / plastic, white
Deckenleuchte; Alu, Stahl, schwarz / Kunststoff, weiss
plafonnier; aluminium, acier, noir / plastique, blanc

L 420, B 420, H 55



21W



3000lm



Remote

99316 LASANA 3

wall/ceiling light; steel, aluminium, black / plastic, white
Wand- / Deckenleuchte; Stahl, Alu, schwarz / Kunststoff, weiss
Applique/Plafonnier; acier, aluminium, noir / plastique, blanc

L 500, B 500, H 95



4x 5,3W



2800lm



9 008606 244966



L 535



9 008606 244959



L 420



9 002759 993160

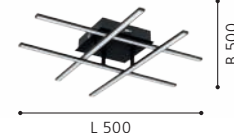

L 500

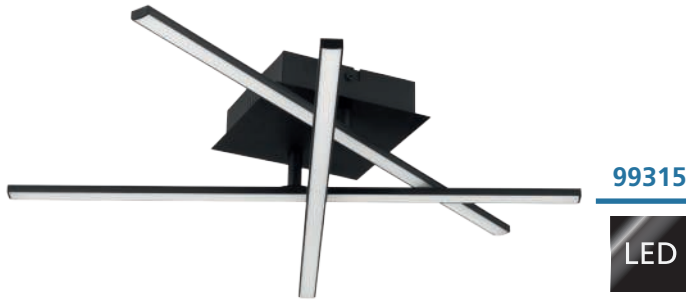

99315

LED



95568

LED



95567

LED

99315 LASANA 3

wall/ceiling light; steel, aluminium, black / plastic, white
Wand- / Deckenleuchte; Stahl, Alu, schwarz / Kunststoff, weiss
Applique/Plafonnier; acier, aluminium, noir / plastique, blanc

L 500, B 145, H 90



3x 3,5W 1500lm

95568 LASANA 1

wall/ceiling light; steel, chrome / plastic, white
Wand- / Deckenleuchte; Stahl, chrom / Kunststoff, weiss
Applique/Plafonnier; acier, chrome / plastique, blanc

L 500, B 500, H 95



4x 5,3W 2800lm

95567 LASANA 1

wall/ceiling light; steel, chrome / plastic, white
Wand- / Deckenleuchte; Stahl, chrom / Kunststoff, weiss
Applique/Plafonnier; acier, chrome / plastique, blanc

L 500, B 160, H 95



3x 3,5W 1500lm



9 002759 993153

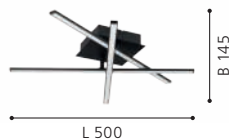

9 002759 955687

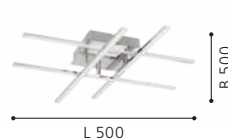

9 002759 955670

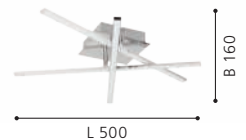



99799

LED



99801

LED

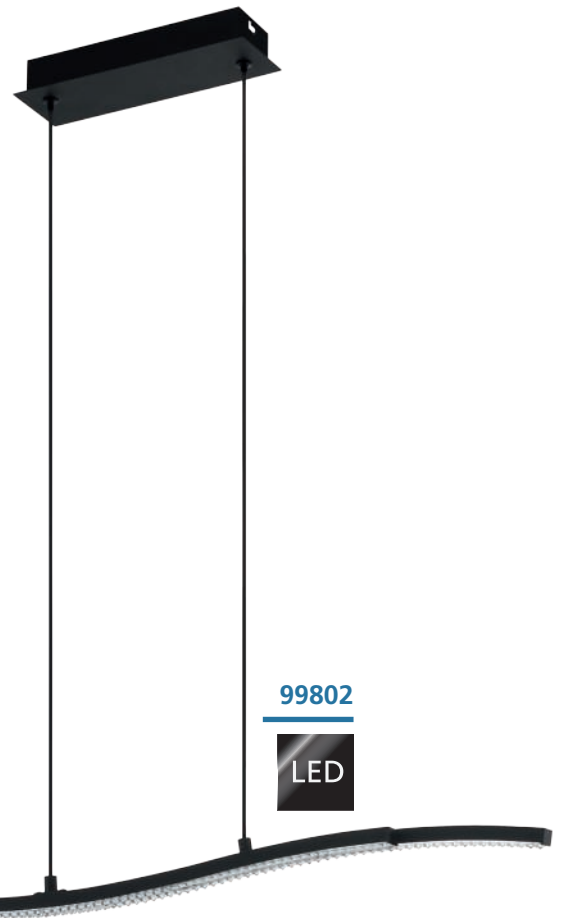

99802

LED

99799 LEJIAS

ceiling light; steel, black / plastic, transparent
 Deckenleuchte; Stahl, schwarz / Kunststoff, transparent
 plafonnier; acier, noir / plastique, transparent

L 450, B 450, H 75

LED

warm
WHITE



21W

3050lm



9 002759 997991

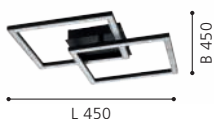

99801 LEJIAS

ceiling light; steel, black / plastic, transparent
 Deckenleuchte; Stahl, schwarz / Kunststoff, transparent
 plafonnier; acier, noir / plastique, transparent

L 780, B 80

LED

warm
WHITE



21,5W

2600lm



9 002759 998011

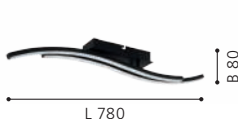

99802 LEJIAS

pendant light; steel, black / plastic, transparent
 Hängeleuchte; Stahl, schwarz / Kunststoff, transparent
 luminaire en suspension; acier, noir / plastique, transparent

L 780, B 80, H 1750

LED

warm
WHITE



21,5W

2600lm



9 002759 998028

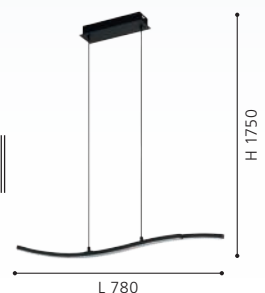



99803



99804



99805



99803 LEJIAS

wall light; steel, black / plastic, transparent
Wandleuchte; Stahl, schwarz / Kunststoff, transparent
Applique; acier, noir / plastique, transparent

L 90, H 285



8W 1050lm



9 002759 998035



99804 LEJIAS

table light; steel, black / plastic, transparent
Tischleuchte; Stahl, schwarz / Kunststoff, transparent
luminaire de table; acier, noir / plastique, transparent

H 330, Base: B 140, T 140



8W 900lm



9 002759 998042



99805 LEJIAS

floor light; steel, black / plastic, transparent
Stehleuchte; Stahl, schwarz / Kunststoff, transparent
lampadaire; acier, noir / plastique, transparent

H 1230, Base: B 230, T 230



16W 2050lm



9 002759 998059





99323

LED



99321

LED



99322

LED

99323 SELVINA 1

ceiling light; steel, aluminium, black / plastic, white
Deckenleuchte; Stahl, Alu, schwarz / Kunststoff, weiss
plafonnier; acier, aluminium, noir / plastique, blanc

L 690, B 300, H 115

LED

warm
WHITE



19W 2700lm

99321 RONCADE 1

wall/ceiling light; steel, aluminium, black / plastic, white
Wand- / Deckenleuchte; Stahl, Alu, schwarz / Kunststoff, weiss
Applique/Plafonnier; acier, aluminium, noir / plastique, blanc

L 650, B 130, H 45

LED

warm
WHITE



21W 2800lm

99322 RONCADE 1

wall/ceiling light; steel, aluminium, black / plastic, white
Wand- / Deckenleuchte; Stahl, Alu, schwarz / Kunststoff, weiss
Applique/Plafonnier; acier, aluminium, noir / plastique, blanc

L 1160, B 180, H 115

LED

warm
WHITE



36W 4600lm



9 002759 993238



9 002759 993214

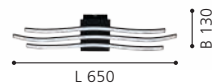

9 002759 993221

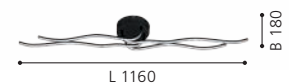



99318



99319



99317



99318 LASANA 3

table light; steel, aluminium, black / plastic, white
Tischleuchte; Stahl, Alu, schwarz / Kunststoff, weiss
luminaire de table; acier, aluminium, noir / plastique, blanc

L 160, B 100, H 460, Base: B 180, T 100



11,5W 1280lm



9 002759 993184



99319 LASANA 3

floor light; steel, aluminium, black / plastic, white
Stehleuchte; Stahl, Alu, schwarz / Kunststoff, weiss
lampadaire; acier, aluminium, noir / plastique, blanc

L 250, B 130, H 1420, Base: B 230, T 150



36W 4700lm



9 002759 993191



99317 LASANA 3

pendant light; steel, aluminium, black / plastic, white
Hängeleuchte; Stahl, Alu, schwarz / Kunststoff, weiss
luminaire en suspension; acier, aluminium, noir / plastique, blanc

L 985, B 80, H 1200



33W 4500lm



9 002759 993177

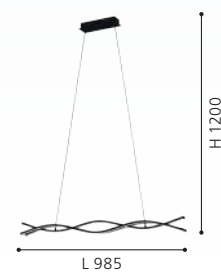

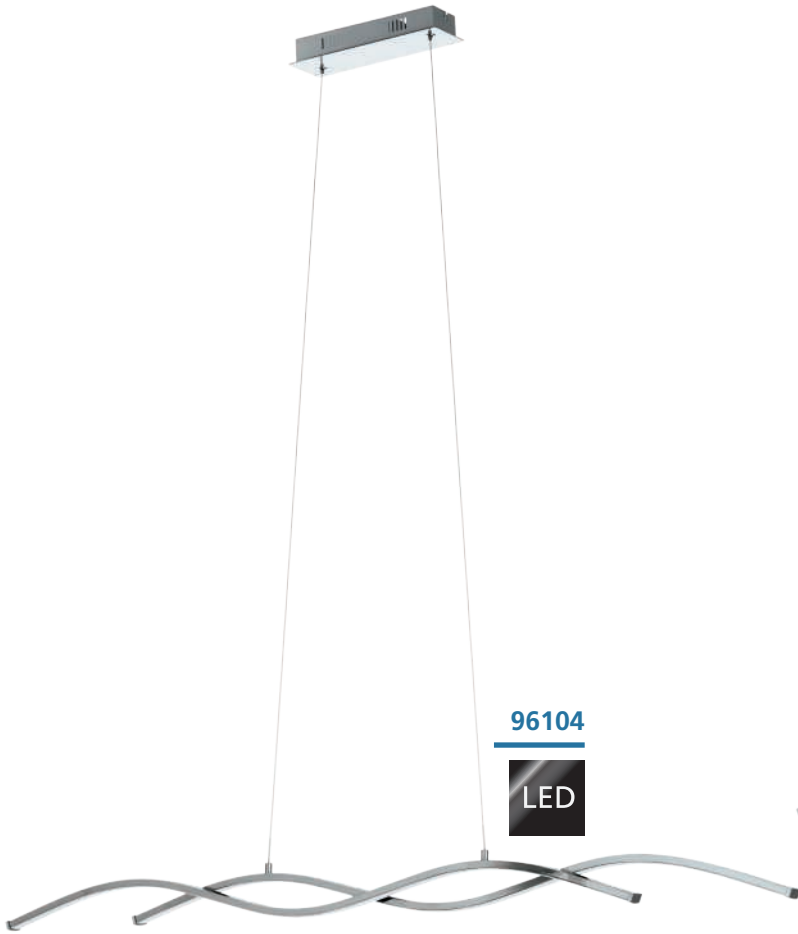

96104

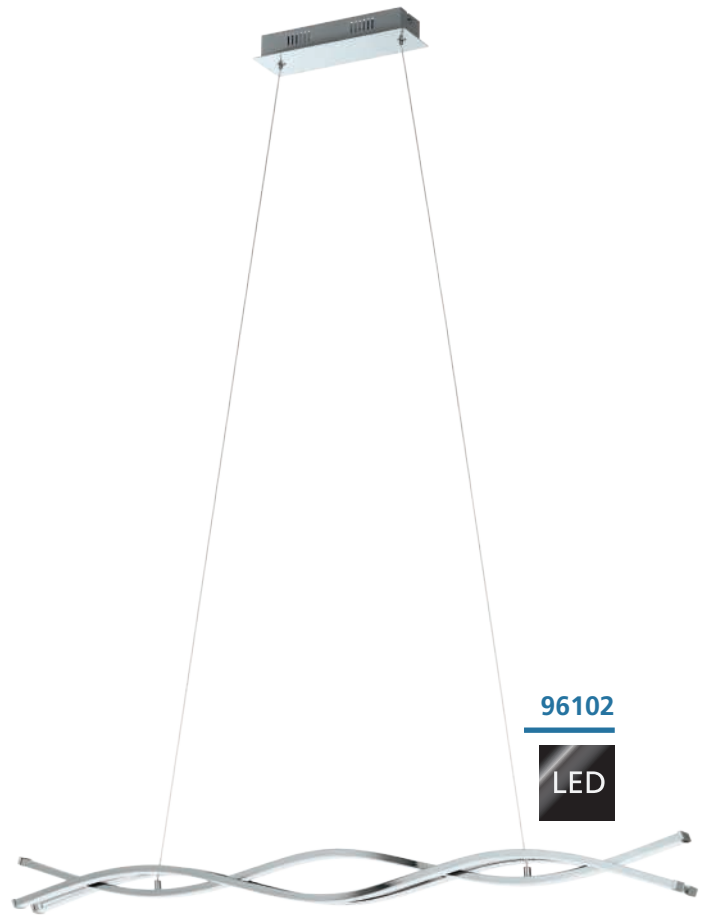

96102



31996



96104 LASANA 2

pendant light; steel, aluminium, chrome / plastic, white
 Hängeleuchte; Stahl, Alu, chrom / Kunststoff, weiss
 luminaire en suspension; acier, aluminium, chrome / plastique, blanc

L 1200, B 80, H 1200



2x 13W 3400lm



9 002759 961046

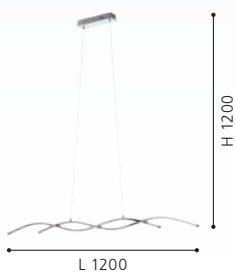

96102 LASANA 2

pendant light; steel, aluminium, chrome / plastic, white
 Hängeleuchte; Stahl, Alu, chrom / Kunststoff, weiss
 luminaire en suspension; acier, aluminium, chrome / plastique, blanc

L 1000, B 80, H 1200



35W 5300lm



9 002759 961022



31996 RONCADE

wall/ceiling light; aluminium, steel, chrome / plastic, white
 Wand- / Deckenleuchte; Alu, Stahl, chrom / Kunststoff, weiss
 Applique/Plafonnier; aluminium, acier, chrome / plastique, blanc

L 1085, B 160, H 125



37W 4700lm



9 002759 319960

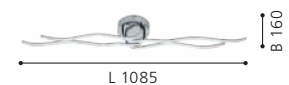

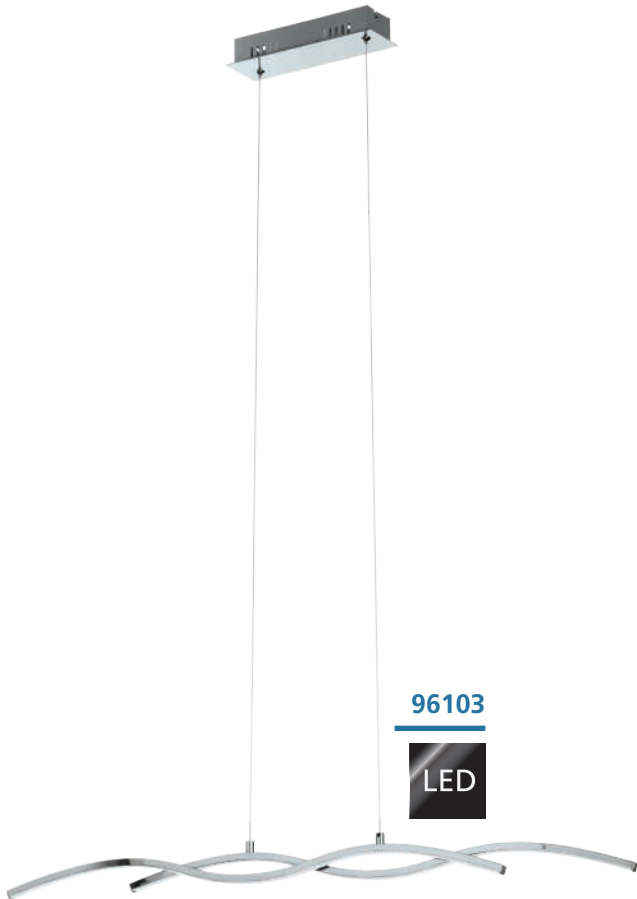

96103



96106



96105



96103 LASANA 2

pendant light; steel, aluminium, chrome / plastic, white
 Hängeleuchte; Stahl, Alu, chrom / Kunststoff, weiss
 luminaire en suspension; acier, aluminium, chrome / plastique, blanc

L 870, B 80, H 1200

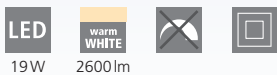

19W 2600lm



9 002759 961039

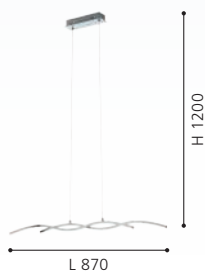

96106 LASANA 2

floor light; steel, aluminium, chrome / plastic, white
 Stehleuchte; Stahl, Alu, chrom / Kunststoff, weiss
 lampadaire; acier, aluminium, chrome / plastique, blanc

L 250, B 130, H 1420



36W 4700lm



9 002759 961060



96105 LASANA 2

table light; steel, aluminium, chrome / plastic, white
 Tischleuchte; Stahl, Alu, chrom / Kunststoff, weiss
 luminaire de table; acier, aluminium, chrome / plastique, blanc

L 160, B 100, H 460



2x 5,5W 1440lm



9 002759 961053

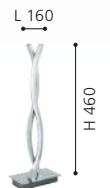



96331

LED



31995

LED



31997

LED

96331 NEVADO

pendant light; aluminium, chrome / plastic, white
Hängeleuchte; Alu, chrom / Kunststoff, weiss
luminaire en suspension; aluminium, chrome / plastique, blanc

L 900, B 80, H 1100



23,6W 3400lm



9 002759 963316

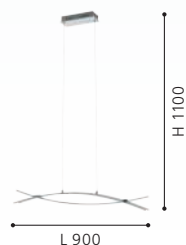

31995 RONCADE

wall/ceiling light; aluminium, steel, chrome / plastic, white
Wand- / Deckenleuchte; Alu, Stahl, chrom / Kunststoff, weiss
Applique/Plafonnier; aluminium, acier, chrome / plastique, blanc

L 650, B 130, H 45



21W 2800lm



9 002759 319953

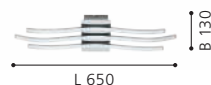

31997 RONCADE

table light; aluminium, steel, chrome / plastic, white
Tischleuchte; Alu, Stahl, chrom / Kunststoff, weiss
luminaire de table; aluminium, acier, chrome / plastique, blanc

L 195, B 150, H 335



8,8W 866lm



9 002759 319977





96332



96308



96329



96332 VALMORA

wall light; aluminium, chrome / plastic, white
Wandleuchte; Alu, chrom / Kunststoff, weiss
Applique; aluminium, chrome / plastique, blanc

L 115, H 450, A 90



9W 1250lm



9 002759 963323



96308 SELVINA

ceiling light; aluminium, chrome / plastic, white
Deckenleuchte; Alu, chrom / Kunststoff, weiss
plafonnier; aluminium, chrome / plastique, blanc

L 745, B 175, H 85



20W 2800lm



9 002759 963088



96329 SELVINA

ceiling light; aluminium, chrome / plastic, white
Deckenleuchte; Alu, chrom / Kunststoff, weiss
plafonnier; aluminium, chrome / plastique, blanc

L 690, B 300, H 115



19W 2700lm



9 002759 963293

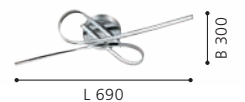



95147

LED

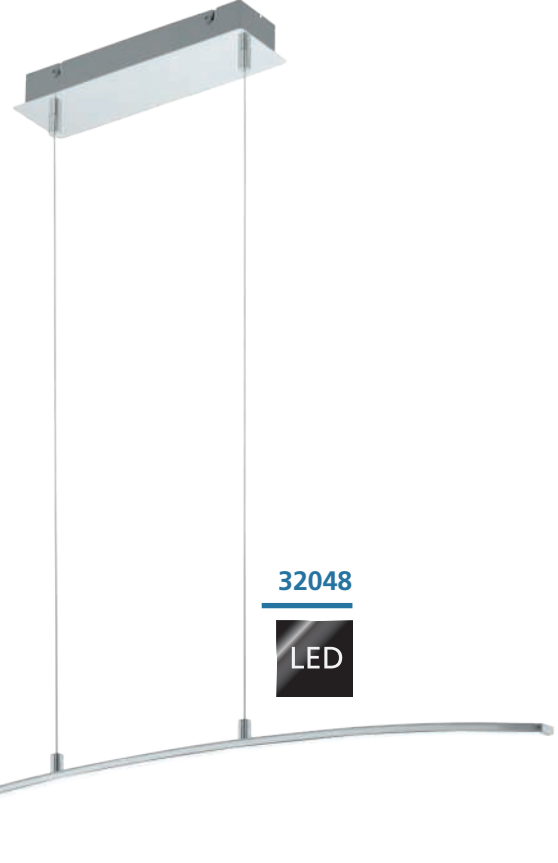

32048

LED

95147 LASANA

pendant light; aluminium, steel, chrome / plastic, white
 Hängeleuchte; Alu, Stahl, chrom / Kunststoff, weiss
 luminaire en suspension; aluminium, acier, chrome / plastique, blanc

L 900, H 1100



30W 3500lm

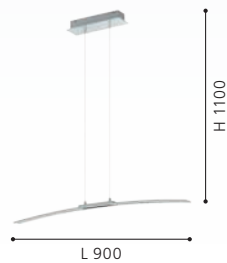

32048 LASANA

pendant light; aluminium, steel, chrome / plastic, white
 Hängeleuchte; Alu, Stahl, chrom / Kunststoff, weiss
 luminaire en suspension; aluminium, acier, chrome / plastique, blanc

L 900, H 1000



15W 1800lm

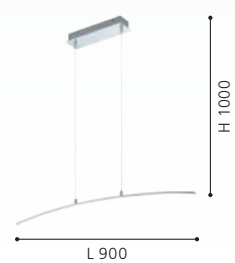

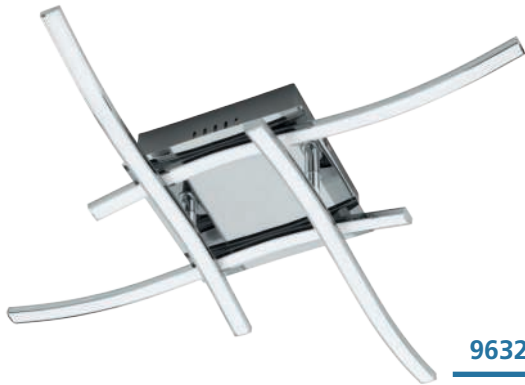

96327

LED



96305

LED



95569

LED



96327 VALMORA

ceiling light; aluminium, chrome / plastic, white
Deckenleuchte; Alu, chrom / Kunststoff, weiss
plafonnier; aluminium, chrome / plastique, blanc

L 560, B 560, H 105



18W 2450lm

96305 NEVADO

ceiling light; aluminium, chrome / plastic, white
Deckenleuchte; Alu, chrom / Kunststoff, weiss
plafonnier; aluminium, chrome / plastique, blanc

L 500, B 500, H 115



18W 2450lm

95569 LASANA 1

wall/ceiling light; steel, chrome / plastic, white
Wand- / Deckenleuchte; Stahl, chrom / Kunststoff, weiss
Applique/Plafonnier; acier, chrome / plastique, blanc

L 500, B 500, H 65



6x 6W 4860lm



9 002759 963279

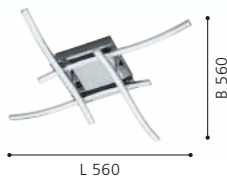

9 002759 963057

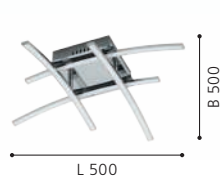

9 002759 955694

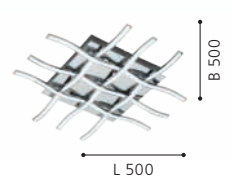



901105

LED



901104

LED

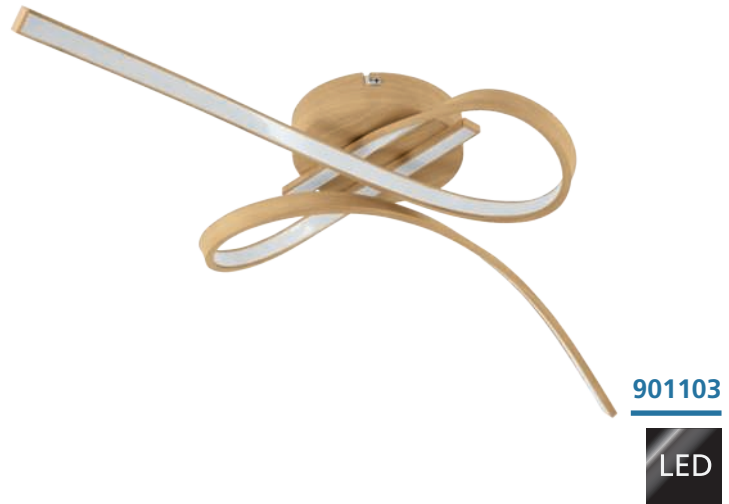

901103

LED

901105 RONCADE 2

wall/ceiling light; steel, aluminium, light brown / plastic, white
Wand- / Deckenleuchte; Stahl, Alu, hellbraun / Kunststoff, weiss
Applique/Plafonnier; acier, aluminium, marron clair / plastique, blanc

L 1100, B 160, H 185

LED

warm
WHITE
4700lm



901104 LASANA 4

wall/ceiling light; steel, aluminium, light brown / plastic, white
Wand- / Deckenleuchte; Stahl, Alu, hellbraun / Kunststoff, weiss
Applique/Plafonnier; acier, aluminium, marron clair / plastique, blanc

L 510, B 510, H 105

LED

warm
WHITE
2500lm



901103 SELVINA 2

ceiling light; steel, aluminium, light brown / plastic, white
Deckenleuchte; Stahl, Alu, hellbraun / Kunststoff, weiss
plafonnier; acier, aluminium, marron clair / plastique, blanc

L 680, B 280, H 140

LED

warm
WHITE
2900lm



9 008606 310319

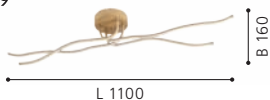

9 008606 310302

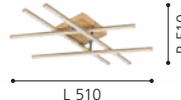

9 008606 310296

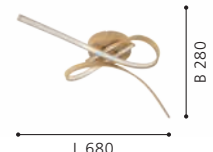



901107



901106



901107 LASANA 4

floor light; steel, aluminium, light brown / plastic, white
 Stehleuchte; Stahl, Alu, hellbraun / Kunststoff, weiss
 lampadaire; acier, aluminium, marron clair / plastique, blanc

L 230, B 110, H 1430, Base: B 220, T 110



36W 4700lm



9 008606 310333



901106 LASANA 4

pendant light; steel, aluminium, light brown / plastic, white
 Hängeleuchte; Stahl, Alu, hellbraun / Kunststoff, weiss
 luminaire en suspension; acier, aluminium, marron clair / plastique, blanc

L 900, B 60, H 1200



35W 5300lm



9 008606 310326

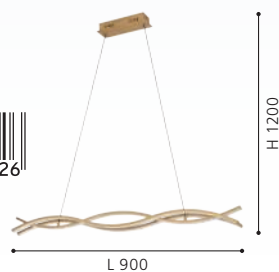



901212



901213



901211



901212 GRISOLIA

pendant light; steel, plastic, brown / plastic, white
 Hängeleuchte; Stahl, Kunststoff, braun / Kunststoff, weiss
 luminaire en suspension; acier, plastique, marron / plastique, blanc

L 1400, B 70, H 1200



20W 2500lm



9 008606 316182

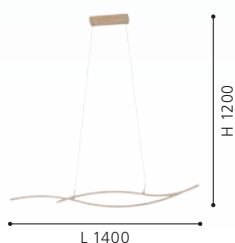

901213 GRISOLIA

table light; steel, plastic, brown / plastic, white
 Tischleuchte; Stahl, Kunststoff, braun / Kunststoff, weiss
 luminaire de table; acier, plastique, marron / plastique, blanc

H 455, Base: B 140, T 90



12W 1500lm



9 008606 316205



901211 GRISOLIA

ceiling light; steel, plastic, brown / plastic, white
 Deckenleuchte; Stahl, Kunststoff, braun / Kunststoff, weiss
 plafonnier; acier, plastique, marron / plastique, blanc

L 850, B 60, H 150



12W 1500lm



9 008606 316168



901214 GRISOLIA

floor light; steel, brown / plastic, white
Stehleuchte; Stahl, braun / Kunststoff, weiss
lampadaire; acier, marron / plastique, blanc

H 1290, Base: B 220, T 220



901214





901207



901208



901206



901207 GRISOLIA

pendant light; steel, plastic, black / plastic, white
 Hängeleuchte; Stahl, Kunststoff, schwarz / Kunststoff, weiss
 luminaire en suspension; acier, plastique, noir / plastique, blanc

L 1400, B 70, H 1200



9 008606 316175

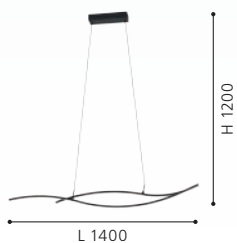

901208 GRISOLIA

table light; steel, plastic, black / plastic, white
 Tischleuchte; Stahl, Kunststoff, schwarz / Kunststoff, weiss
 luminaire de table; acier, plastique, noir / plastique, blanc

H 455, Base: B 140, T 90



9 008606 316199



901206 GRISOLIA

ceiling light; steel, plastic, black / plastic, white
 Deckenleuchte; Stahl, Kunststoff, schwarz / Kunststoff, weiss
 plafonnier; acier, plastique, noir / plastique, blanc

L 849, B 60, H 150



9 008606 316151

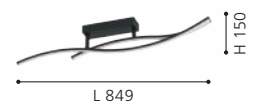



901209

LED



99715

LED

901209 GRISOLIA

floor light; steel, black / plastic, white
 Stehleuchte; Stahl, schwarz / Kunststoff, weiss
 lampadaire; acier, noir / plastique, blanc

H 1290, Base: B 220, T 220



20W 2500lm



9 008606 316212



99715 PICACHA

floor light; steel, black / plastic, white
 Stehleuchte; Stahl, schwarz / Kunststoff, weiss
 lampadaire; acier, noir / plastique, blanc

H 1625, Base: B 150, T 150



29W 3500lm



9 002759 997151





900472

LED



901138

LED

900472 RUOTALE

pendant light; aluminium, steel, black / plastic, white
 Hängeleuchte; Alu, Stahl, schwarz / Kunststoff, weiss
 luminaire en suspension; aluminium, acier, noir / plastique, blanc

H 1500, Ø 550



36W 4500lm



9 008606 239931



901138 RUOTALE

pendant light; aluminium, steel, black / plastic, white
 Hängeleuchte; Alu, Stahl, schwarz / Kunststoff, weiss
 luminaire en suspension; aluminium, acier, noir / plastique, blanc

H 1500, Ø 700



42W 5000lm



9 008606 303526



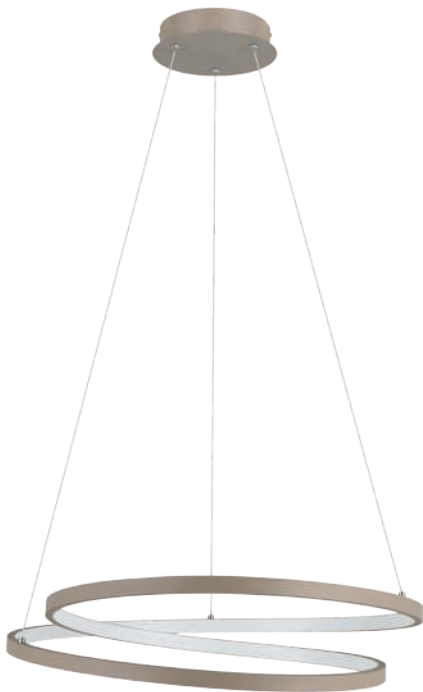

901139



LED



901141



LED



901637



LED



901139 RUOTALE

pendant light; aluminium, steel, sandy / plastic, white
Hängeleuchte; Alu, Stahl, sandfarben / Kunststoff, weiss
luminaire en suspension; aluminium, acier, couleur sable / plastique, blanc

H 1500, Ø 550



36W 4500lm



9 008606 303533



901141 RUOTALE

pendant light; aluminium, steel, sandy / plastic, white
Hängeleuchte; Alu, Stahl, sandfarben / Kunststoff, weiss
luminaire en suspension; aluminium, acier, couleur sable / plastique, blanc

H 1500, Ø 700



42W 5000lm



9 008606 303540



901637 PARRUTA

pendant light; aluminium, steel, black / plastic, white
Hängeleuchte; Alu, Stahl, schwarz / Kunststoff, weiss
luminaire en suspension; aluminium, acier, noir / plastique, blanc

H 1500, Ø 990



40W 4300lm



9 008606 315697





900471

LED

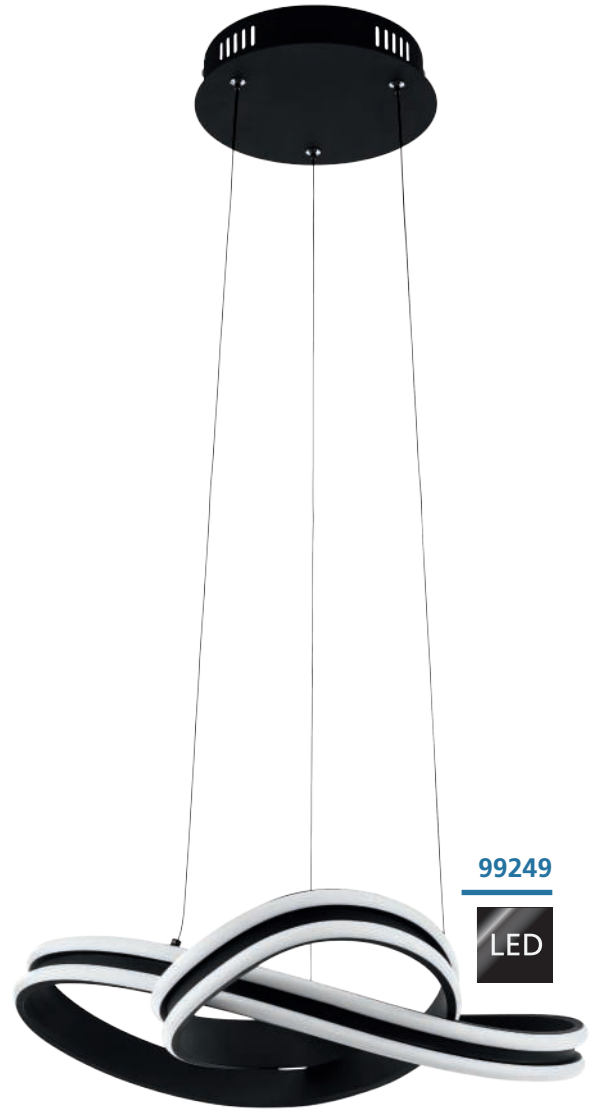

99249

LED

900471 RUOTALE

ceiling light; aluminium, steel, black / plastic, white
 Deckenleuchte; Alu, Stahl, schwarz / Kunststoff, weiss
 plafonnier; aluminium, acier, noir / plastique, blanc

H 55, Ø 450



36W 4400lm

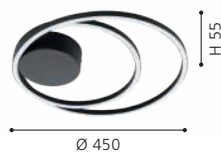

99249 CORREDERA

pendant light; steel, black / plastic, white
 Hängeleuchte; Stahl, schwarz / Kunststoff, weiss
 luminaire en suspension; acier, noir / plastique, blanc

H 1200, Ø 500



34W 5100lm

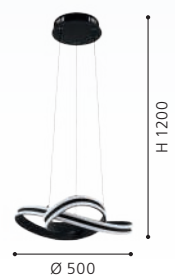



900419



99395



900419 ROLIMARE

ceiling light; aluminium, satin nickel / plastic, white
Deckenleuchte; Alu, nickel-matt / Kunststoff, weiss
plafonnier; aluminium, nickel mat / plastique, blanc

L 420, B 400, H 130



35W 5500lm

99395 ROLIMARE

ceiling light; aluminium, black / plastic, white
Deckenleuchte; Alu, schwarz / Kunststoff, weiss
plafonnier; aluminium, noir / plastique, blanc

L 420, B 400, H 130



35W 5500lm



9 008606 240999

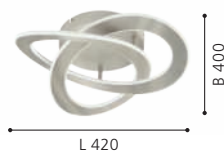

9 002759 993955





99788

LED

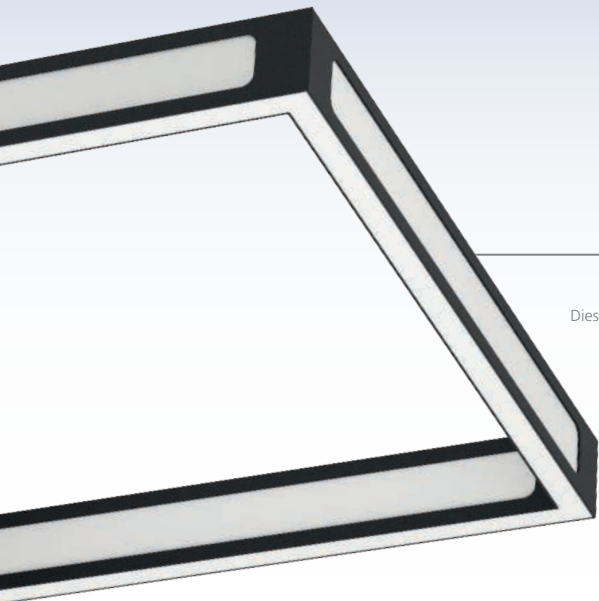
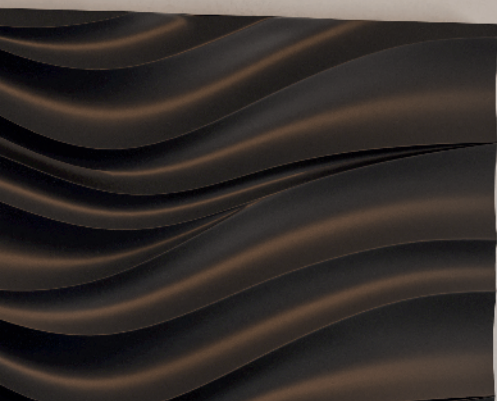

ALTAFLOR

These luminaires have an additional glow on the inside.
Diese Leuchten haben einen zusätzlichen Lichtschein nach Innen.
Ces luminaires ont une lueur supplémentaire à l'intérieur.

99788 ALTAFLOR

ceiling light; steel, black / plastic, white
Deckenleuchte; Stahl, schwarz / Kunststoff, weiss
plafonnier; acier, noir / plastique, blanc

L 650, B 300, H 70



8x 2,8W



3040lm



9 002759 997885

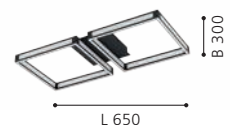

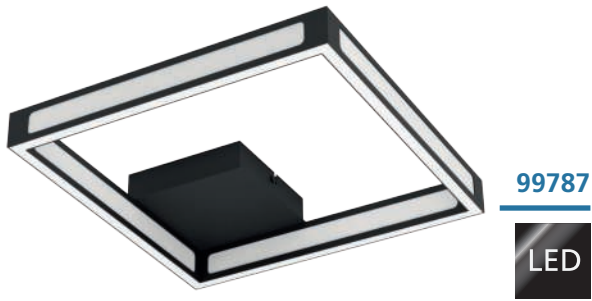

99787



99789

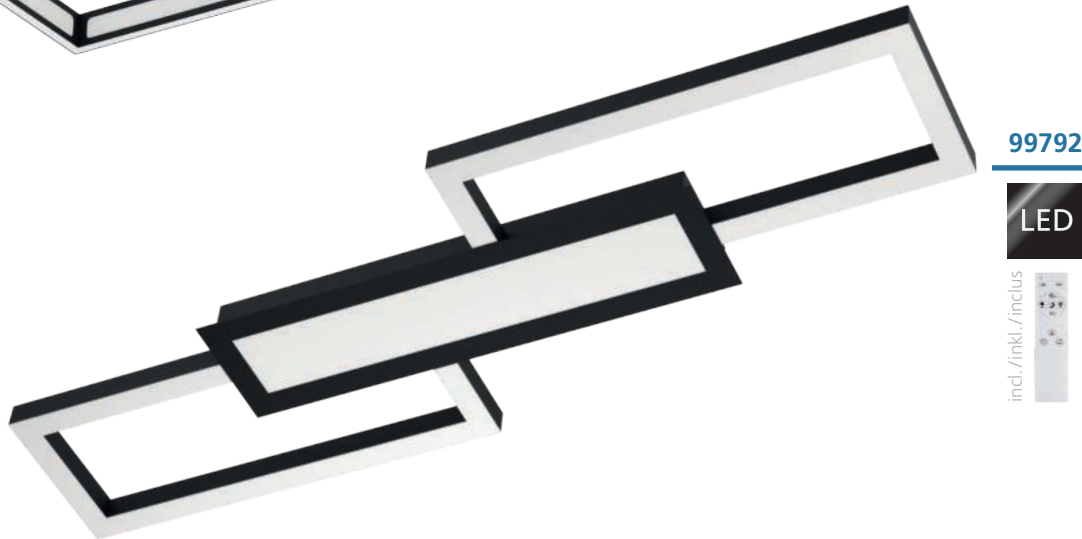

99792



incl./mkl./inclus

99787 ALTAFLOR

ceiling light; steel, black / plastic, white
 Deckenleuchte; Stahl, schwarz / Kunststoff, weiss
 plafonnier; acier, noir / plastique, blanc

L 315, B 315, H 70

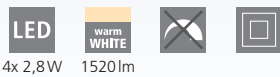

4x 2,8W 1520lm

99789 ALTAFLOR

ceiling light; steel, black / plastic, white
 Deckenleuchte; Stahl, schwarz / Kunststoff, weiss
 plafonnier; acier, noir / plastique, blanc

L 1000, B 315, H 70



12x 2,8W 4560lm

99792 MONIROTE

ceiling light; steel, aluminium, black / plastic, white
 Deckenleuchte; Stahl, Alu, schwarz / Kunststoff, weiss
 plafonnier; acier, aluminium, noir / plastique, blanc

L 780, B 260, H 45



37W 4450lm Remote



9 002759 997878

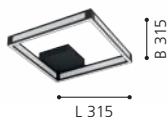

9 002759 997892

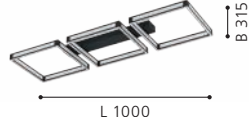

9 002759 997922

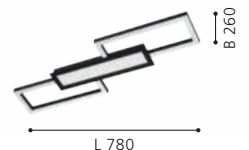



99784

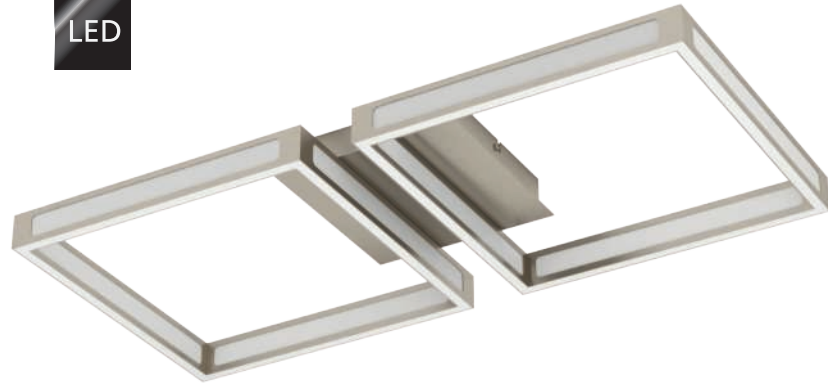

99785

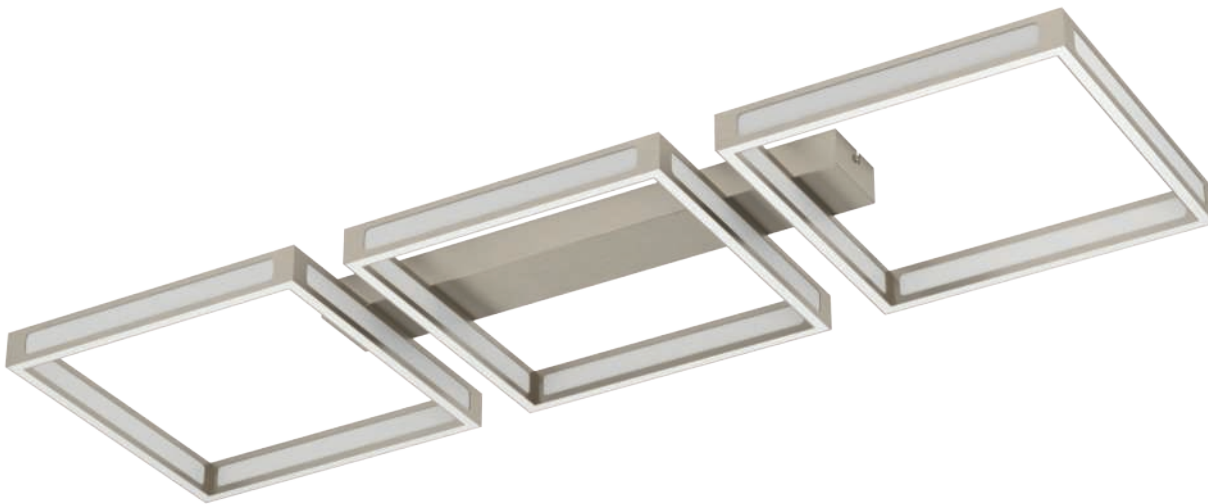

99786



99784 ALTAFLOR

ceiling light; steel, satin nickel / plastic, white
Deckenleuchte; Stahl, nickel-matt / Kunststoff, weiss
plafonnier; acier, nickel mat / plastique, blanc

L 315, B 315, H 70



4x 2,8W 1520lm

99785 ALTAFLOR

ceiling light; steel, satin nickel / plastic, white
Deckenleuchte; Stahl, nickel-matt / Kunststoff, weiss
plafonnier; acier, nickel mat / plastique, blanc

L 650, B 300, H 70



8x 2,8W 3040lm

99786 ALTAFLOR

ceiling light; steel, satin nickel / plastic, white
Deckenleuchte; Stahl, nickel-matt / Kunststoff, weiss
plafonnier; acier, nickel mat / plastique, blanc

L 1000, B 315, H 70



12x 2,8W 4560lm



9 002759 997847

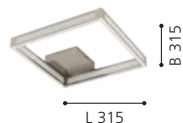

9 002759 997854

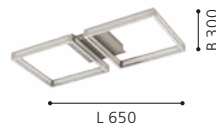

9 002759 997861

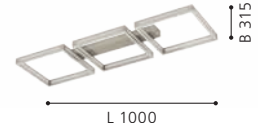



99791

LED

incl./inkl./inclus



99791 MONIROTE

ceiling light; steel, aluminium, satin nickel / plastic, white
 Deckenleuchte; Stahl, Alu, nickel-matt / Kunststoff, weiss
 plafonnier; acier, aluminium, nickel mat / plastique, blanc

L 780, B 260, H 45



37W



4450lm



Remote

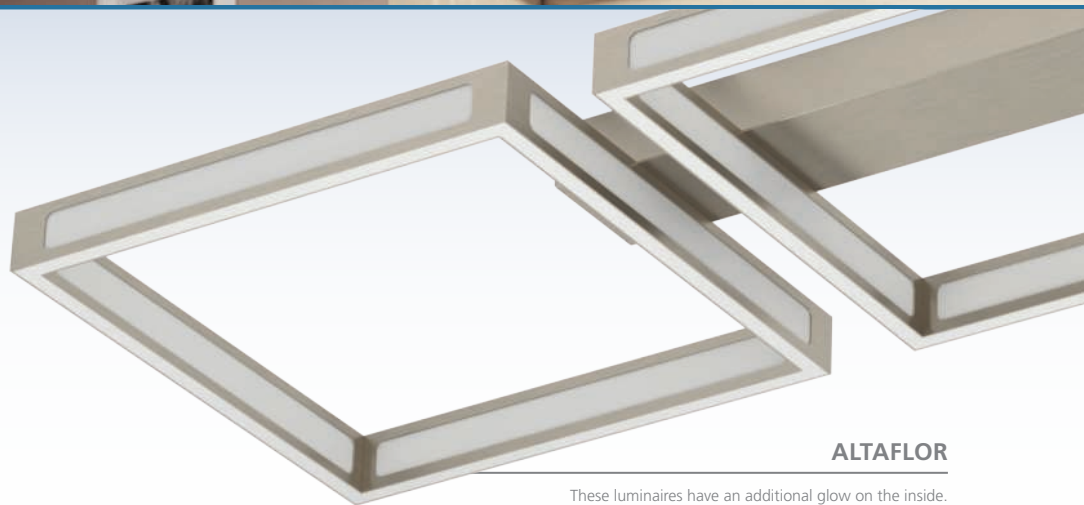

ALTAFLOR

These luminaires have an additional glow on the inside.
 Diese Leuchten haben einen zusätzlichen Lichtschein nach Innen.
 Ces luminaires ont une lueur supplémentaire à l'intérieur.



9 002759 997915





98889

LED



99559

LED

98889 PALOZZA 1

wall light; aluminium, satin nickel / plastic, white
Wandleuchte; Alu, nickel-matt / Kunststoff, weiss
Applique; aluminium, nickel mat / plastique, blanc

L 170, H 425, A 60



10W 1300lm



9 002759 988890



L 170

H 425

99559 PALOZZA 1

table light; aluminium, satin nickel / plastic, white
Tischleuchte; Alu, nickel-matt / Kunststoff, weiss
luminaire de table; aluminium, nickel mat / plastique, blanc

L 150, B 110, H 420, Base: Ø 110



11W 1400lm



9 002759 995591

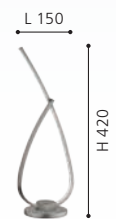

Ø 110

H 420

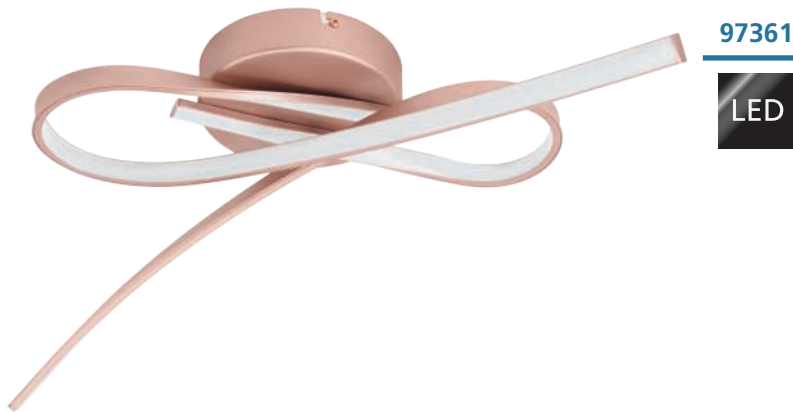

97361

LED

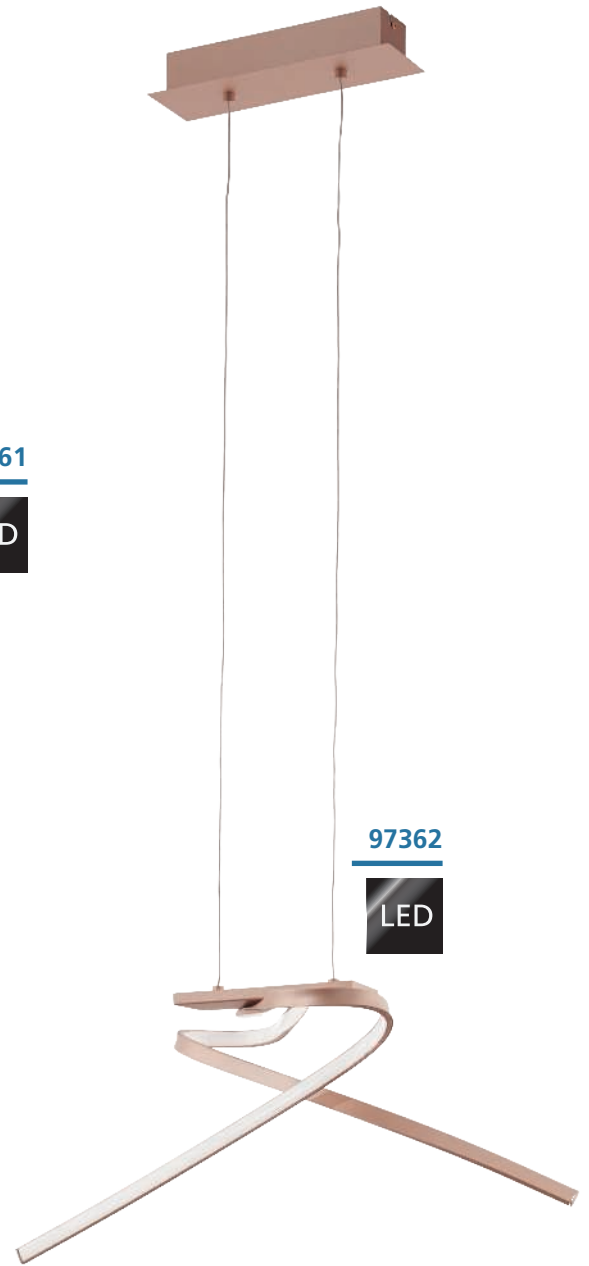

97362

LED

97361 PALOZZA

ceiling light; aluminium, rose gold / plastic, white
Deckenleuchte; Alu, roségold / Kunststoff, weiss
plafonnier; aluminium, rose or / plastique, blanc

L 705, B 315, H 125

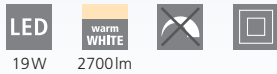

19W 2700lm



9 002759 973612

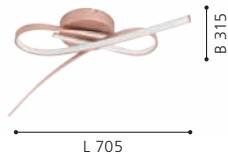

97362 PALOZZA

pendant light; aluminium, rose gold / plastic, white
Hängeleuchte; Alu, roségold / Kunststoff, weiss
luminaire en suspension; aluminium, rose or / plastique, blanc

L 705, B 315, H 1100



19W 2600lm



9 002759 973629

