

LOFT

#COSY
#CLEAR

Separate rooms and designated spaces for working, eating and leisure are a thing of the past. Free spirits need open spaces. The loft design imparts a sense of freedom and tranquillity, and the minimalist furnishings and accessories ensure your space still feels cosy and liveable. Simple yet sophisticated. Clean lines and dark surfaces offset by brighter accents are the main features of the loft aesthetic. Recreate this chic look in your own home with EGLO.

Die Zeiten in denen Wohnen, Essen und Arbeiten in getrennten Räumen stattfanden, sind vorbei. Freigeister brauchen Freiräume, um sich wohl zu fühlen. Der Loft-Look steht für Freiheit und Gelassenheit, welcher durch minimalistische Möbel und Accessoires trotzdem ein gemütliches Raumgefühl gibt. Einfach und doch raffiniert. Klare Linien, dunkle Oberflächen, kontrastiert von hellen Akzenten sind die Hauptmerkmale des Loft-Looks und mit EGLO holen Sie sich diesen Loft-Charm ganz einfach nach Hause.

Finie l'époque où l'on vivait, mangeait et travaillait dans des pièces distinctes ! Les esprits libres ont besoin d'espace pour se sentir bien. Le style loft est synonyme de liberté et de sérénité, mais donne néanmoins le sentiment d'un espace chaleureux grâce à un mobilier et à des accessoires minimalistes. Simple, mais sophistiqué. Des lignes épurées avec des surfaces foncées, contrastées par des touches claires, sont les principales caractéristiques du style loft. Appropriiez-vous son élégance dans votre intérieur avec EGLO.

HORNWOOD 2 78	BOYLE 80	HORNWOOD 82-83	LACEY 84-85	BRAMERTON 86-87	AYLES 87	CHIEVELEY 88-89	HALKIN 90
CONSETT 90-91	FAMBOROUGH 92-93	NAFFERTON 94-95	LITTLETON 96-97	BASILDON 1 98	BASILDON 98-99	CALLOW 100	SHERBURN 101
BUDDON 102	POCKLEY 102	BAILRIGG 102-103	TOWNSHEND 104-109	TOWNSHEND 5 110-113	PALMORLA 113	CARLTON 1 114-116,120-122	CARLTON 7 116-117
CARLTON 4 118	CARLTON 6 118	CARLTON 5 119	CARLTON-P 122	CARLTON 124-127	STYPE 128-129	STRAITON 130	VERNHAM 133
TARBES 134,146-151	CARLTON 2 134	STILLINGTON 136-137	STILLINGTON 1 138-139	SOUTHERY 140-141	LINTMILL 142	CASTANUELO 144-145	ROCCAMENA 152
CLEVEDON 153	NEWTOWN 154-155	AUSTELL 156	PLIMSOLL 159	WAVERTON 160-161	HORNWOOD 1 162	BIDFORD 163	LANTADA 163
CHESTER 164	CHESTER 1 164	CORETTO 2 165	HAPTON 165	COPLEY 166-167	WRINGTON 168-169	POMPEYA 171	WRINGTON 1 171
BAZELY 173	SALLICANO 173	TWICKEN 174-175	MATLOCK 176-179				

 This product is available in different colors and shapes./ Dieser Artikel ist in unterschiedlichen Farben und Formen verfügbar.
Cet article est disponible en différentes couleurs et formes.

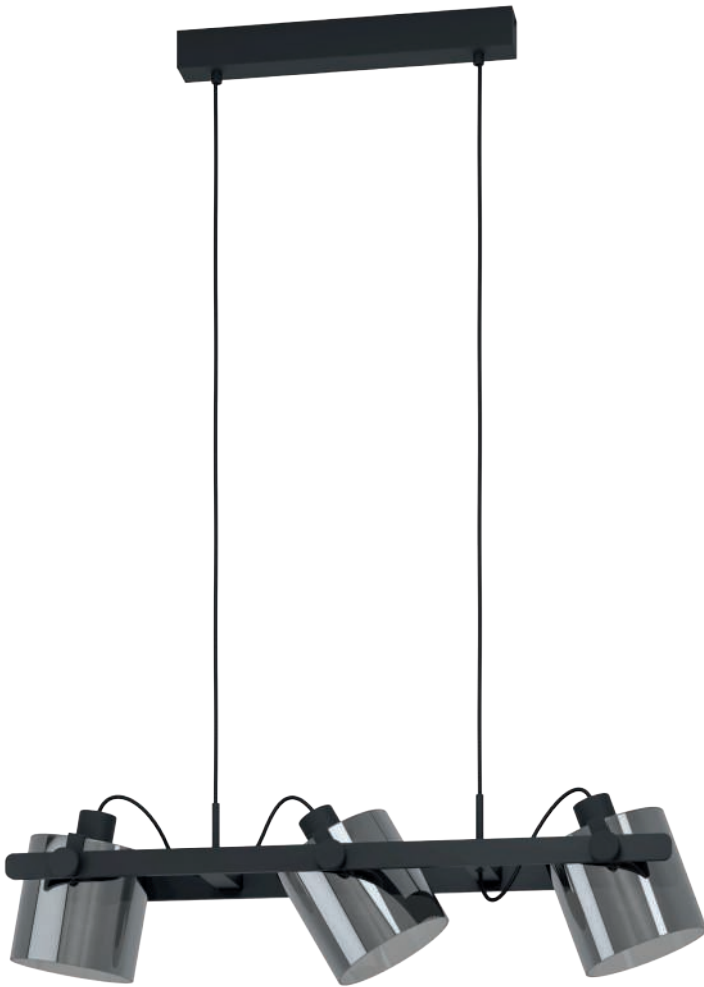

43606



DETAIL HORNWOOD 2

The heads of this luminaire can be swiveled individually.

Die Leuchtenköpfe sind individuell schwenkbar.

Les têtes de ce luminaire peuvent être pivotées individuellement.



43606 HORNWOOD 2

pendant light; steel, wood, black / glass vaporized, black-transparent

Hängeleuchte; Stahl, Holz, schwarz / Glas bedampft, schwarz-transparent

luminaire en suspension; acier, bois, noir / verre vaporisé, noir transparent

L 780, B 150, H 1100



E27



3x 40W



9 002759 436063

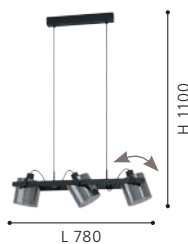

43671 HORNWOOD 2

ceiling light; steel, wood, black / glass vaporized, black-transparent

Deckenleuchte; Stahl, Holz, schwarz / Glas bedampft, schwarz-transparent

plafonnier; acier, bois, noir / verre vaporisé, noir transparent

L 1110, B 225, H 265



E27



4x 40W



9 002759 436711

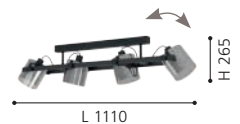



43671





43635



43635 BOYLE

ceiling light; steel, wood, black, brown / plastic, white
Deckenleuchte; Stahl, Holz, schwarz, braun / Kunststoff, weiss
plafonnier; acier, bois, noir, marron / plastique, blanc

L 780, B 170, H 300



E27



3x 10W



9 002759 436353



L 780

H 300

43636 BOYLE

pendant light; steel, wood, black, brown / plastic, white
Hängeleuchte; Stahl, Holz, schwarz, braun / Kunststoff, weiss
luminaire en suspension; acier, bois, noir, marron / plastique, blanc

L 780, B 170, H 1100



E27



3x 10W



9 002759 436360



L 780

H 1100



43636





43517



43424



DETAIL HORNWOOD

The heads can be adjusted or fixed in position with the lateral screws.

Die Köpfe können mittels den seitlichen Schrauben verstellt oder fixiert werden.

Les têtes peuvent être réglées ou fixées à l'aide des vis latérales.



43518



43517 HORNWOOD

pendant light; steel, black, creme / wood, brown
Hängeleuchte; Stahl, schwarz, creme / Holz, braun
luminaire en suspension; acier, noir, crème / bois, marron

L 780, B 210, H 1100



E27 3x 60W



9 002759 435172

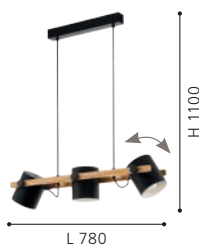

43424 HORNWOOD

pendant light; steel, black, creme / wood, brown
Hängeleuchte; Stahl, schwarz, creme / Holz, braun
luminaire en suspension; acier, noir, crème / bois, marron

L 1100, B 180, H 1100



E27 4x 28W



9 002759 434243

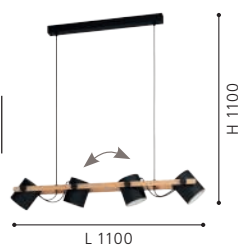

43518 HORNWOOD

wall light; steel, black, creme / wood, brown
Wandleuchte; Stahl, schwarz, creme / Holz, braun
applique; acier, noir, crème / bois, marron

Ø 170



E27 1x 28W



9 002759 435189



Ø 170



43558



43519



43521



43558 HORNWOOD

ceiling light; steel, black, creme / wood, brown
Deckenleuchte; Stahl, schwarz, creme / Holz, braun
plafonnier; acier, noir, crème / bois, marron

L 1000, B 190, H 275



E27



4x 28W



9 002759 435585

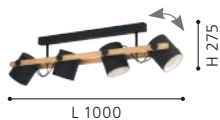

43519 HORNWOOD

table light; steel, black, creme / wood, brown
Tischleuchte; Stahl, schwarz, creme / Holz, braun
luminaire de table; acier, noir, crème / bois, marron

L 210, B 180, H 420, Base: Ø 180



E27



1x 28W



9 002759 435196



43521 HORNWOOD

floor light; steel, black, creme / wood, brown
Stehleuchte; Stahl, schwarz, creme / Holz, braun
lampadaire; acier, noir, crème / bois, marron

L 230, B 230, H 1400, Base: Ø 230



E27



1x 28W



9 002759 435219

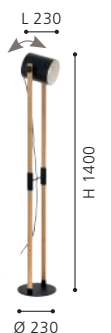



43735



43612



LACEY

These luminaires have design elements made of real wood.

Diese Leuchten verfügen über Design-elemente aus Echtholz.

Ces luminaires disposent d'éléments de design en bois véritable.

43735 LACEY

wall light; steel, wood, black, brown / steel, black, creme
Wandleuchte; Stahl, Holz, schwarz, braun / Stahl, schwarz, creme
Applique; acier, bois, noir, marron / acier, noir, crème

L 135, H 275, A 265



E14



1x 40W



9 002759 437350



43612 LACEY

pendant light; steel, wood, black, brown / steel, black, creme
Hängeleuchte; Stahl, Holz, schwarz, braun / Stahl, schwarz, creme
luminaire en suspension; acier, bois, noir, marron / acier, noir, crème

L 780, B 160, H 1100



E27



3x 40W



9 002759 436124





43611



43613



43614



43611 LACEY

ceiling light; steel, wood, black, brown / steel, black, creme
Deckenleuchte; Stahl, Holz, schwarz, braun / Stahl, schwarz, creme
plafonnier; acier, bois, noir, marron / acier, noir, crème

L 780, B 160, H 335



E27



3x 40W



9 002759 436117



L 780

43613 LACEY

table light; steel, wood, black, brown / steel, black, creme
Tischleuchte; Stahl, Holz, schwarz, braun / Stahl, schwarz, creme
luminaire de table; acier, bois, noir, marron / acier, noir, crème

L 255, B 135, H 485, Base: B 170, T 120



E14



1x 40W



9 002759 436131



B 170

43614 LACEY

floor light; steel, wood, black, brown / steel, black, creme
Stehleuchte; Stahl, Holz, schwarz, braun / Stahl, schwarz, creme
lampadaire; acier, bois, noir, marron / acier, noir, crème

L 310, B 160, H 1595, Base: B 280, T 200



E27



1x 40W



9 002759 436148

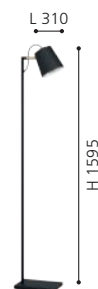

B 280



43752 BRAMERTON

pendant light; steel, wood, black, brown
 Hängeleuchte; Stahl, Holz, schwarz, braun
 luminaire en suspension; acier, bois, noir, marron

L 810, B 120, H 1100

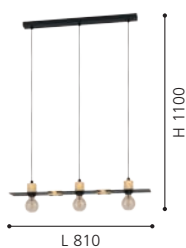

43751 BRAMERTON

ceiling light; steel, wood, black, brown
 Deckenleuchte; Stahl, Holz, schwarz, braun
 plafonnier; acier, bois, noir, marron

L 810, B 120, H 100

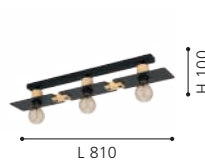

43753 BRAMERTON

wall light; steel, wood, black, brown
 Wandleuchte; Stahl, Holz, schwarz, braun
 Applique; acier, bois, noir, marron

L 120, H 110, A 215

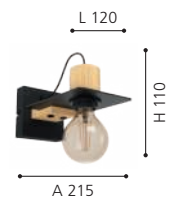



43749

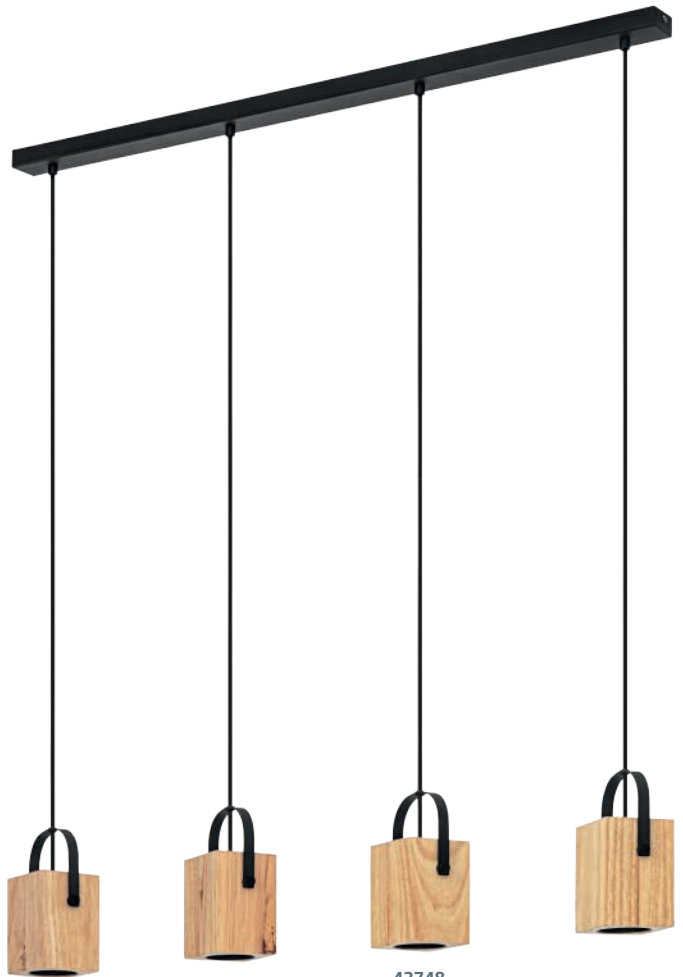

43748



43754



43754 BRAMERTON

table light; steel, wood, black, brown
Tischleuchte; Stahl, Holz, schwarz, braun
luminaire de table; acier, bois, noir, marron

L 120, B 140, H 310, Base: B 120, T 140



E27



1x 40W



9 002759 437541



43749 AYLES

table light; steel, black / wood, brown
Tischleuchte; Stahl, schwarz / Holz, braun
luminaire de table; acier, noir / bois, marron

H 475, Base: Ø 260



GU10



1x 3W



warm
WHITE
1x
250lm



9 002759 437497



43748 AYLES

pendant light; steel, black / wood, brown
Hängeleuchte; Stahl, schwarz / Holz, braun
luminaire en suspension; acier, noir / bois, marron

L 930, B 85, H 1100



GU10



4x 3W



warm
WHITE
4x
250lm



9 002759 437480

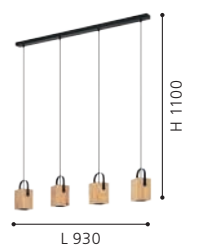



43541

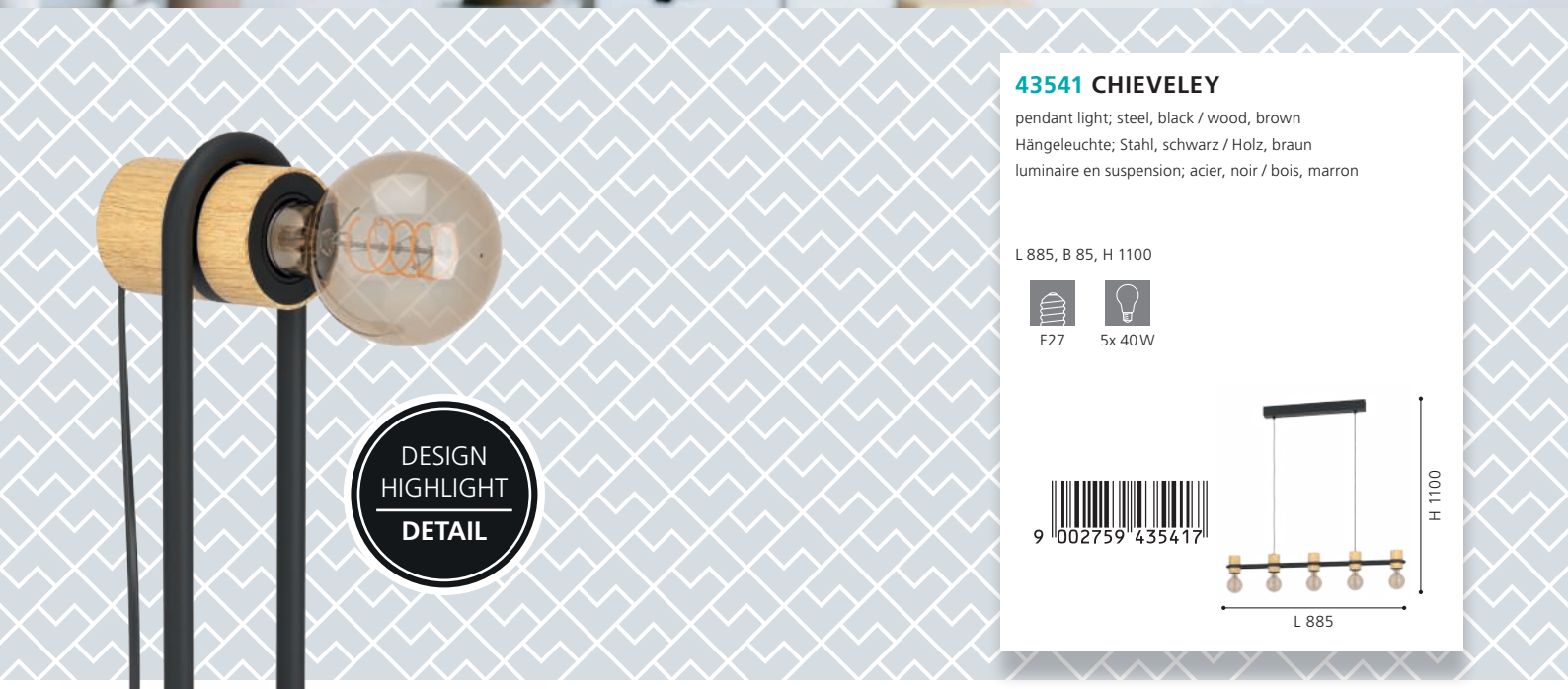

DESIGN
HIGHLIGHT
DETAIL

43541 CHIEVELEY

pendant light; steel, black / wood, brown
Hängeleuchte; Stahl, schwarz / Holz, braun
luminaire en suspension; acier, noir / bois, marron

L 885, B 85, H 1100



E27



5x 40W



9 002759 435417

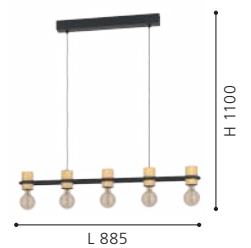



43542



43543

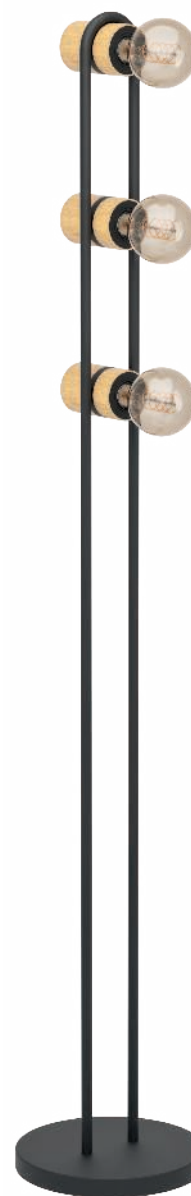

43544



43542 CHIEVELEY

wall light; steel, black / wood, brown
Wandleuchte; Stahl, schwarz / Holz, braun
Applique; acier, noir / bois, marron

L 285, H 90, A 115



E27



2x 40W



9 002759 435424

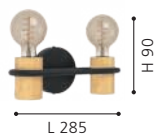

43543 CHIEVELEY

table light; steel, black / wood, brown
Tischleuchte; Stahl, schwarz / Holz, braun
luminaire de table; acier, noir / bois, marron

L 85, B 90, H 410, Base: Ø 155



E27



1x 28W



9 002759 435431



43544 CHIEVELEY

floor light; steel, black / wood, brown
Stehleuchte; Stahl, schwarz / Holz, braun
lampadaire; acier, noir / bois, marron

L 85, B 90, H 1405, Base: Ø 230



E27



3x 28W



9 002759 435448



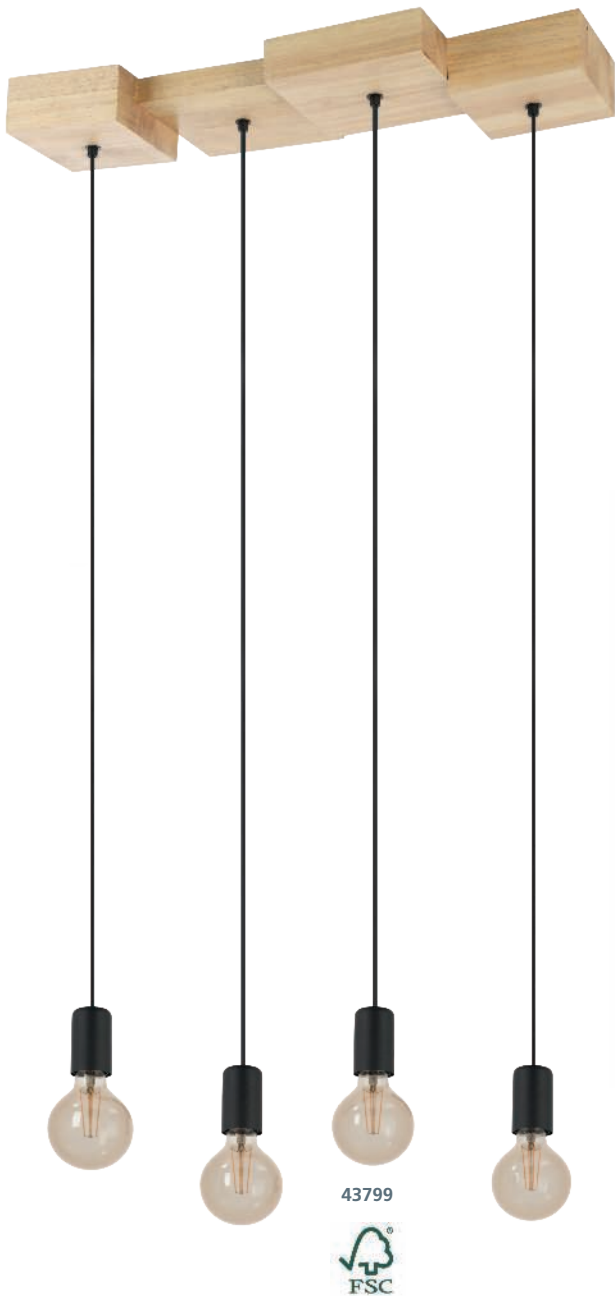

43799
FSC



43798
FSC



43724
FSC

43799 HALKIN

pendant light; wood, steel, brown, black
Hängeleuchte; Holz, Stahl, braun, schwarz
luminaire en suspension; bois, acier, marron, noir

L 720, B 250, H 1100



E27 4x 40W



9 002759 437992



43798 HALKIN

ceiling light; wood, steel, brown, black
Deckenleuchte; Holz, Stahl, braun, schwarz
plafonnier; bois, acier, marron, noir

L 400, B 430, H 140



E27 4x 40W



9 002759 437985

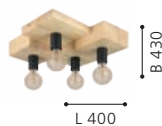

43724 CONSETT

ceiling light; steel, wood, black, brown
Deckenleuchte; Stahl, Holz, schwarz, braun
plafonnier; acier, bois, noir, marron

L 780, B 250, H 115



E27 6x 40W



9 002759 437244

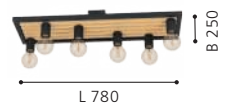



43725



43725 CONSETT

pendant light; steel, wood, black, brown
 Hängeleuchte; Stahl, Holz, schwarz, braun
 luminaire en suspension; acier, bois, noir, marron

L 780, B 250, H 1100



E27



6x 40W



9 002759 437251

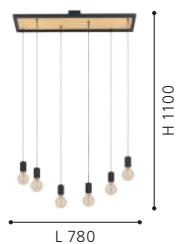

DESIGN
 HIGHLIGHT
 DETAIL



43413



43413 FAMBOROUGH

pendant light; steel, wood, black, natural
Hängeleuchte; Stahl, Holz, schwarz, natur
luminaire en suspension; acier, bois, noir, naturel

L 160, B 105, H 1100



E27



1x 40W



9 002759 434137

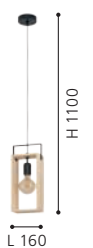



43414



43416



43415



43414 FAMBOROUGH

pendant light; steel, wood, black, natural
Hängeleuchte; Stahl, Holz, schwarz, natur
luminaire en suspension; acier, bois, noir, naturel

L 1000, B 160, H 1100



E27



5x 40W



9 002759 434144

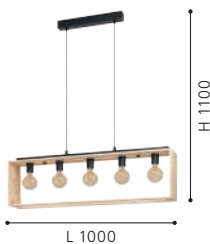

43416 FAMBOROUGH

table light; steel, wood, black, natural
Tischleuchte; Stahl, Holz, schwarz, natur
luminaire de table; acier, bois, noir, naturel

L 305, B 160, H 565, Base: B 300, T 160



E27



3x 40W



9 002759 434168



43415 FAMBOROUGH

table light; steel, wood, black, natural
Tischleuchte; Stahl, Holz, schwarz, natur
luminaire de table; acier, bois, noir, naturel

L 165, B 100, H 400, Base: B 160, T 100



E27



1x 40W



9 002759 434151





43744



43744 NAFFERTON

pendant light; steel, wood, black, brown

Hängeleuchte; Stahl, Holz, schwarz, braun

luminaire en suspension; acier, bois, noir, marron

L 800, B 100, H 1100



E27



3x 40W



9 002759 437442





43743



43746



43745



43743 NAFFERTON

pendant light; steel, wood, black, brown
Hängeleuchte; Stahl, Holz, schwarz, braun
luminaire en suspension; acier, bois, noir, marron

L 100, B 100, H 1100



E27



1x 40W



9 002759 437435

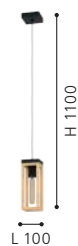

43746 NAFFERTON

table light; steel, wood, black, brown
Tischleuchte; Stahl, Holz, schwarz, braun
luminaire de table; acier, bois, noir, marron

L 100, B 100, H 280



E27



1x 40W



9 002759 437466



43745 NAFFERTON

wall light; steel, wood, black, brown
Wandleuchte; Stahl, Holz, schwarz, braun
Applique; acier, bois, noir, marron

L 100, H 280, A 125



E27



1x 40W



9 002759 437459

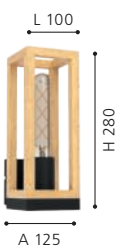



44051



44053



44051 LITTLETON

pendant light; steel, black / wood, brown
Hängeleuchte; Stahl, schwarz / Holz, braun
luminaire en suspension; acier, noir / bois, marron

L 110, B 100, H 1100



E27



1x 40W



9 002759 440510



44053 LITTLETON

pendant light; steel, black / wood, brown
Hängeleuchte; Stahl, schwarz / Holz, braun
luminaire en suspension; acier, noir / bois, marron

L 1160, B 55, H 1100



E27



4x 40W



9 002759 440534





44055



44054



44055 LITTLETON

wall light; steel, black / wood, brown
 Wandleuchte; Stahl, schwarz / Holz, braun
 Applique; acier, noir / bois, marron

L 110, H 330, A 115



E27



1x 40W



9 002759 440558



44054 LITTLETON

pendant light; steel, black / wood, brown
 Hängeleuchte; Stahl, schwarz / Holz, braun
 luminaire en suspension; acier, noir / bois, marron

H 1500, Ø 500



E27



6x 40W



9 002759 440541





DETAIL BASILDON

The black metal ring is individually adjustable.
Der schwarze Metallring ist individuell verstellbar.
L'anneau en métal noir est réglable individuellement.



43569



43461



43462



43569 BASILDON 1

table light; steel, wood, black, brown / fabric, black
Tischleuchte; Stahl, Holz, schwarz, braun / Textil, schwarz
luminaire de table; acier, bois, noir, marron / tissu, noir

H 425, Ø 230, Base: Ø 150



E27 1x 40W



9 002759 435691



43461 BASILDON

pendant light; steel, wood, black, brown
Hängeleuchte; Stahl, Holz, schwarz, braun
luminaire en suspension; acier, bois, noir, marron

L 190, B 160, H 1100



E27 1x 40W



9 002759 434618



43462 BASILDON

pendant light; steel, wood, black, brown
Hängeleuchte; Stahl, Holz, schwarz, braun
luminaire en suspension; acier, bois, noir, marron

L 780, B 160, H 1100



E27 3x 40W



9 002759 434625

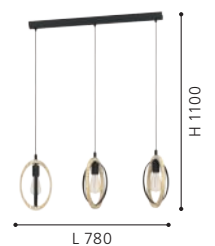



43736



43464



43463



43736 BASILDON

ceiling light; steel, wood, black, brown
Deckenleuchte; Stahl, Holz, schwarz, braun
plafonnier; acier, bois, noir, marron

H 375, Ø 320



E27



1x 40W



9 002759 437367

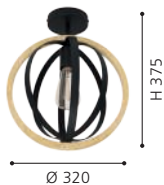

43464 BASILDON

table light; steel, wood, black, brown
Tischleuchte; Stahl, Holz, schwarz, braun
luminaire de table; acier, bois, noir, marron

L 190, B 160, H 345, Base: Ø 155



E27



1x 40W



9 002759 434649



43463 BASILDON

pendant light; steel, wood, black, brown
Hängeleuchte; Stahl, Holz, schwarz, braun
luminaire en suspension; acier, bois, noir, marron

H 1300, Ø 615



E27



3x 40W



9 002759 434632





43756

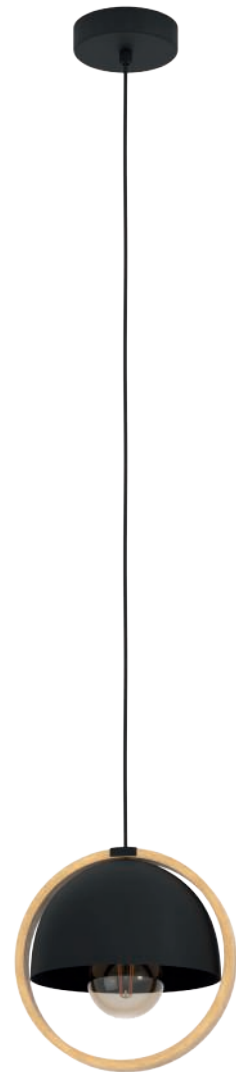

43755



43756 CALLOW

pendant light; steel, wood, black, brown
 Hängeleuchte; Stahl, Holz, schwarz, braun
 luminaire en suspension; acier, bois, noir, marron

L 930, B 230, H 1100



E27



3x 40W



9 002759 437565



43755 CALLOW

pendant light; steel, wood, black, brown
 Hängeleuchte; Stahl, Holz, schwarz, braun
 luminaire en suspension; acier, bois, noir, marron

H 1100, Ø 230



E27



1x 40W



9 002759 437558





43739 SHERBURN

pendant light; steel, wood, black, brown
 Hängeleuchte; Stahl, Holz, schwarz, braun
 luminaire en suspension; acier, bois, noir, marron

L 770, B 200, H 1100



E27



3x 40W



9 002759 437398



43738 SHERBURN

ceiling light; steel, wood, black, brown
 Deckenleuchte; Stahl, Holz, schwarz, braun
 plafonnier; acier, bois, noir, marron

L 800, B 200, H 255



E27



3x 40W



9 002759 437381



DETAIL 43898, 44013



These wall luminaires are easily adjustable using the cable wrap or the adjustable rod. No wall outlet is required for installation, just a socket below the luminaires.

Diese Wandleuchten sind einfach verstellbar mit Hilfe der Wickelung des Kabels bzw. des verstellbaren Stabes. Für die Montage ist kein Wandauslas notwendig, sondern nur eine Steckdose unterhalb der Leuchten.

Ces appliques sont facilement réglables à l'aide de l'enroulement du câble ou de la tige réglable. Pour le montage, il n'est pas nécessaire de prévoir une sortie murale, mais seulement une prise de courant sous le luminaire.



43898



44013



43904



43898 BUDDON

wall light; wood, steel, brown, black
Wandleuchte; Holz, Stahl, braun, schwarz
Applique; bois, acier, marron, noir

L 55, H 2600, A 80



E27 1x 13W



9 002759 438982

44013 POCKLEY

wall light; wood, steel, brown, black
Wandleuchte; Holz, Stahl, braun, schwarz
Applique; bois, acier, marron, noir

L 45, H 295, A 160



E27 1x 10W



9 002759 440138

43904 BAILRIGG

table light; steel, wood, black, brown
Tischleuchte; Stahl, Holz, schwarz, braun
luminaire de table; acier, bois, noir, marron

L 65, B 45, H 330, Base: B 130, T 80



E27 1x 40W



9 002759 439040



43901



43903

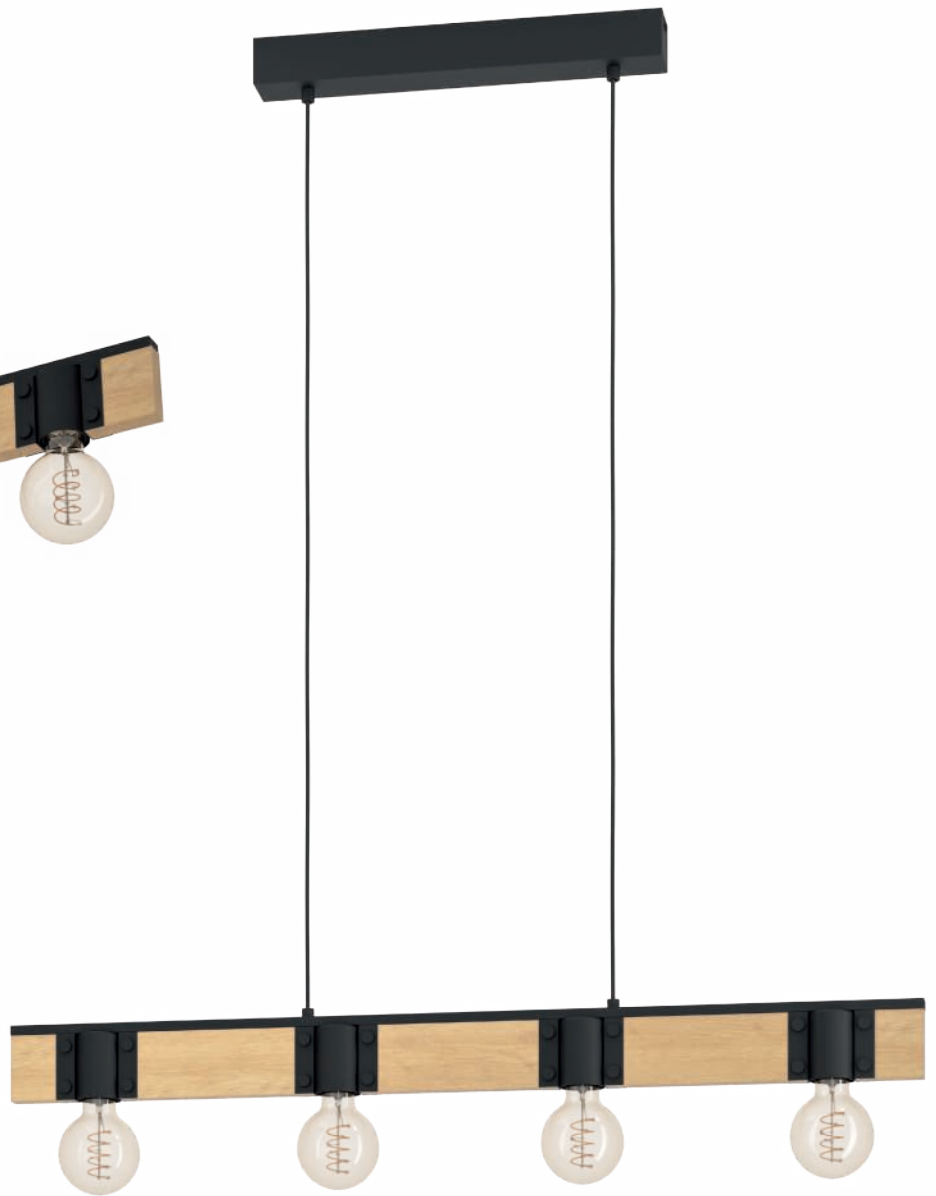

43902



43903 BAILRIGG

wall light; steel, wood, black, brown
Wandleuchte; Stahl, Holz, schwarz, braun
Applique; acier, bois, noir, marron

L 55, H 135, A 140



E27



1x 40W



9 002759 439033

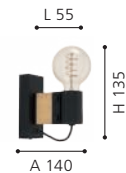

43901 BAILRIGG

ceiling light; steel, wood, black, brown
Deckenleuchte; Stahl, Holz, schwarz, braun
plafonnier; acier, bois, noir, marron

L 655, B 100, H 45



E27



3x 40W



9 002759 439019

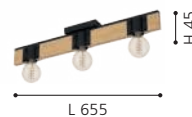

43902 BAILRIGG

pendant light; steel, wood, black, brown
Hängeleuchte; Stahl, Holz, schwarz, braun
luminaire en suspension; acier, bois, noir, marron

L 895, B 45, H 1100



E27



4x 40W



9 002759 439026

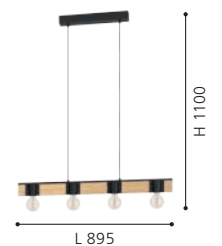



43704



43705



43704 TOWNSHEND

pendant light; steel, white / wood, brown
 Hängeleuchte; Stahl, weiss / Holz, braun
 luminaire en suspension; acier, blanc / bois, marron

L 700, B 105, H 1100



E27



4x 60W



9 002759 437046



43705 TOWNSHEND

pendant light; steel, white / wood, brown
 Hängeleuchte; Stahl, weiss / Holz, braun
 luminaire en suspension; acier, blanc / bois, marron

L 1000, B 100, H 1100



E27



6x 60W



9 002759 437053

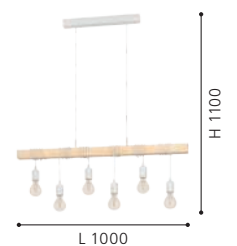



43706



44082



33163

43706 TOWNSHEND

wall light; steel, white / wood, brown
Wandleuchte; Stahl, weiss / Holz, braun
Applique; acier, blanc / bois, marron

L 65, H 215, A 185



E27



1x 10W



9 002759 437060



L 65

H 215

A 185

44082 TOWNSHEND

ceiling light; steel, white / wood, brown
Deckenleuchte; Stahl, weiss / Holz, braun
plafonnier; acier, blanc / bois, marron

L 550, B 105, H 265



E27



3x 60W



9 002759 440824

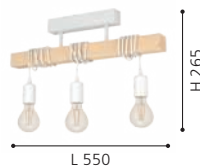

H 265

L 550

33163 TOWNSHEND

table light; steel, white / wood, brown
Tischleuchte; Stahl, weiss / Holz, braun
luminaire de table; acier, blanc / bois, marron

L 175, B 155, H 500, Base: Ø 155



E27



1x 10W



9 002759 331634

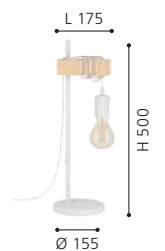

L 175

H 500

Ø 155



DETAIL TOWNSHEND

Thanks to the long cable of the luminaire heads, the height can be adjusted individually.

Durch das lange Kabel der Leuchtenköpfe kann die Höhe individuell eingestellt werden.

Grâce au long câble des têtes de luminaire, la hauteur peut être réglée individuellement.

43513 TOWNSHEND

pendant light; steel, wood, black, brown
Hängeleuchte; Stahl, Holz, schwarz, braun
luminaire en suspension; acier, bois, noir, marron

L 1000, B 100, H 1100



E27



6x 60W



9 002759 435134

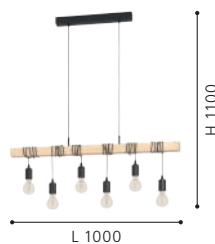

44099 TOWNSHEND

pendant light; wood, steel, brown, black
Hängeleuchte; Holz, Stahl, braun, schwarz
luminaire en suspension; bois, acier, marron, noir

L 1500, B 100, H 1100



E27



9x 60W



9 002759 440992

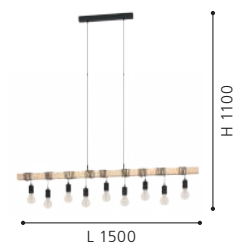

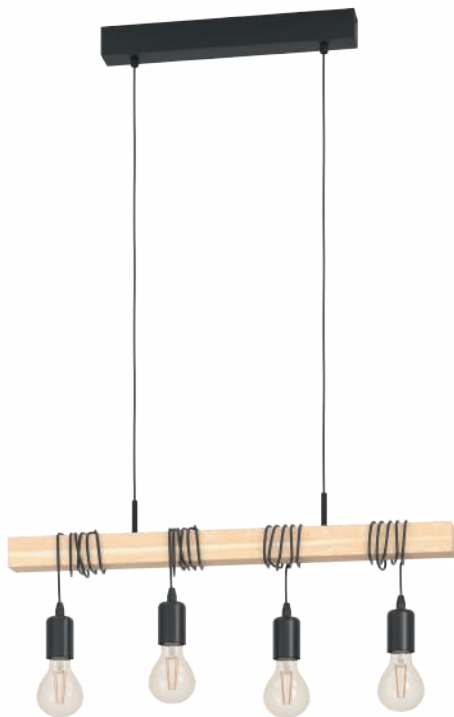

43512



43511



43512 TOWNSHEND

pendant light; steel, wood, black, brown
 Hängeleuchte; Stahl, Holz, schwarz, braun
 luminaire en suspension; acier, bois, noir, marron

L 700, B 105, H 1100



E27



4x 60W



9 002759 435127



43511 TOWNSHEND

ceiling light; steel, wood, black, brown
 Deckenleuchte; Stahl, Holz, schwarz, braun
 plafonnier; acier, bois, noir, marron

L 550, B 105, H 265



E27



3x 60W



9 002759 435110

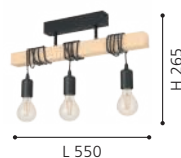

DESIGN
HIGHLIGHT
DETAIL



43514 TOWNSHEND

wall light; steel, wood, black, brown
Wandleuchte; Stahl, Holz, schwarz, braun
Applique; acier, bois, noir, marron

L 65, H 215, A 190



E27 1x 10W



9 002759 435141



43515 TOWNSHEND

table light; steel, wood, black, brown
Tischleuchte; Stahl, Holz, schwarz, braun
luminaire de table; acier, bois, noir, marron

L 175, B 155, H 500, Base: Ø 155



E27 1x 10W



9 002759 435158



43516 TOWNSHEND

floor light; steel, wood, black, brown
Stehleuchte; Stahl, Holz, schwarz, braun
lampadaire; acier, bois, noir, marron

L 205, B 250, H 1665, Base: Ø 250



E27 2x 10W



9 002759 435165





44062



44062 TOWNSHEND

pendant light; steel, black / wood, black
Hängeleuchte; Stahl, schwarz / Holz, schwarz
luminaire en suspension; acier, noir / bois, noir

L 1000, B 100, H 1100



E27



6x 40W



9 002759 440626

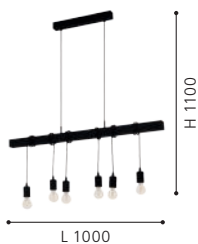



44074



44075



44074 TOWNSHEND 5

ceiling light; steel, wood, black, brown
Deckenleuchte; Stahl, Holz, schwarz, braun
plafonnier; acier, bois, noir, marron

L 550, B 200, H 360



E27



3x 60W



9 002759 440749



L 550

H 360

44075 TOWNSHEND 5

pendant light; steel, wood, black, brown
Hängeleuchte; Stahl, Holz, schwarz, braun
luminaire en suspension; acier, bois, noir, marron

L 700, B 200, H 1100



E27



4x 60W



9 002759 440756



L 700

H 1100

44078 TOWNSHEND 5

wall light; steel, wood, black, brown
Wandleuchte; Stahl, Holz, schwarz, braun
Applique; acier, bois, noir, marron

L 140, H 275, A 240



E27



1x 60W



9 002759 440787



A 240

H 275



44078





44076



44077



DETAIL TOWNSHEND 5

Thanks to the long cable of the luminaire heads, the height can be adjusted individually.

Durch das lange Kabel der Leuchtenköpfe kann die Höhe individuell eingestellt werden.

Grâce au long câble des têtes de luminaire, la hauteur peut être réglée individuellement.

44076 TOWNSHEND 5

pendant light; steel, wood, black, brown
Hängeleuchte; Stahl, Holz, schwarz, braun
luminaire en suspension; acier, bois, noir, marron

L 1000, B 200, H 1100



E27



6x 60W



9 002759 440763



44077 TOWNSHEND 5

pendant light; steel, wood, black, brown
Hängeleuchte; Stahl, Holz, schwarz, braun
luminaire en suspension; acier, bois, noir, marron

L 1500, B 200, H 1100



E27



9x 60W



9 002759 440770

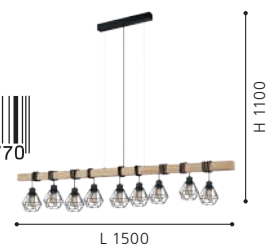



44081



44079



44094



44081 TOWNSHEND 5

floor light; steel, wood, black, brown
 Stehleuchte; Stahl, Holz, schwarz, braun
 lampadaire; acier, bois, noir, marron

L 400, B 250, H 1665, Base: Ø 250



E27 2x 60W

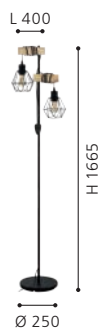

9 002759 440817

44079 TOWNSHEND 5

table light; steel, wood, black, brown
 Tischleuchte; Stahl, Holz, schwarz, braun
 luminaire de table; acier, bois, noir, marron

L 220, B 155, H 500, Base: Ø 155



E27 1x 60W



9 002759 440794

44094 PALMORLA

pendant light; steel, wood, black, brown
 Hängeleuchte; Stahl, Holz, schwarz, braun
 luminaire en suspension; acier, bois, noir, marron

L 760, B 160, H 1100



E27 3x 60W



9 002759 440947

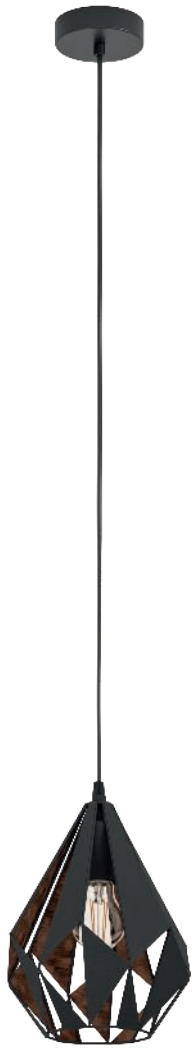

49997

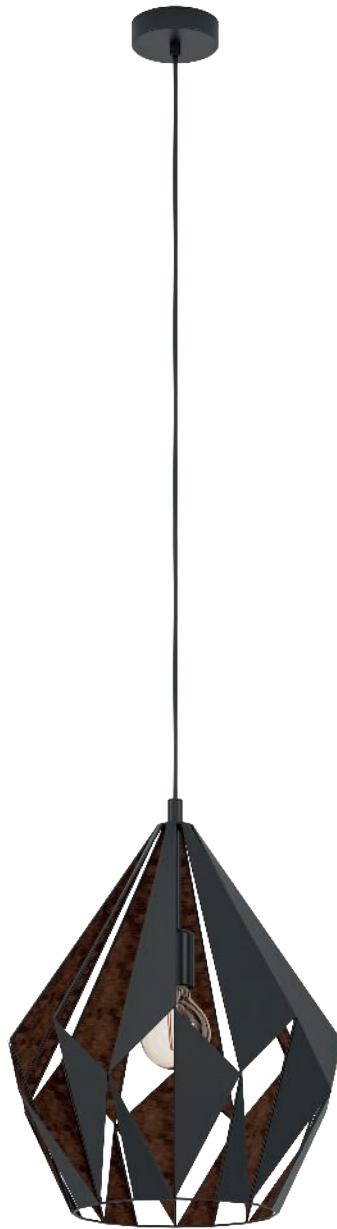

49878

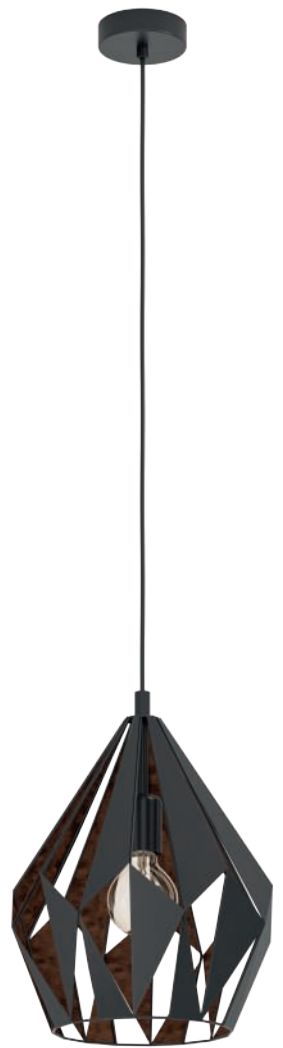

49254

49997 CARLTON 1

pendant light; steel, black, copper
Hängeleuchte; Stahl, schwarz, kupfer
luminaire en suspension; acier, noir, cuivre

H 1100, Ø 205



E27 1x 60W



9 002759 499976



49878 CARLTON 1

pendant light; steel, black, copper
Hängeleuchte; Stahl, schwarz, kupfer
luminaire en suspension; acier, noir, cuivre

H 1500, Ø 385



E27 1x 60W



9 002759 498788



49254 CARLTON 1

pendant light; steel, black, copper
Hängeleuchte; Stahl, schwarz, kupfer
luminaire en suspension; acier, noir, cuivre

H 1100, Ø 310



E27 1x 60W



9 002759 492540





49991



49994



49992

DETAIL 49992

This wall luminaires can be mounted with the head up and down.

Diese Wandleuchten können mit dem Kopf nach oben und unten montiert werden.

Cette appliques peuvent être montée avec la tête en haut ou en bas.



49991 CARLTON 1

pendant light; steel, black, copper
Hängeleuchte; Stahl, schwarz, kupfer
luminaire en suspension; acier, noir, cuivre

L 805, B 205, H 1100



E27



3x 60W



9 002759 499914



49994 CARLTON 1

floor light; steel, black, copper
Stehleuchte; Stahl, schwarz, kupfer
lampadaire; acier, noir, cuivre

H 1525, Ø 255, Base: Ø 230



E27



1x 60W



9 002759 499945

Ø 255



H 1525

Ø 230



49992 CARLTON 1

wall light; steel, black, copper
Wandleuchte; Stahl, schwarz, kupfer
Applique; acier, noir, cuivre

L 205, H 330, A 220



E27



1x 60W



9 002759 499921





43846



43716

43846 CARLTON 1

pendant light; steel, black, copper
Hängeleuchte; Stahl, schwarz, kupfer
luminaire en suspension; acier, noir, cuivre

L 1455, B 385, H 1070



E27



6x 40W



9 002759 438463



L 1455

H 1070

43716 CARLTON 7

spot; steel, black, antique copper coloured
Spot; Stahl, schwarz, kupferfarben-antik
spot; acier, noir, aspect cuivre-antique

L 420, B 160, H 255



E27



2x 40W



9 002759 437169



L 420

H 255



43717



43718



43715

43717 CARLTON 7

spot; steel, black, antique copper coloured
Spot; Stahl, schwarz, kupferfarben-antik
spot; acier, noir, aspect cuivre-antique

L 730, B 160, H 255



E27



3x 40W



9 002759 437176



L 730

H 255

43715 CARLTON 7

spot; steel, black, antique copper coloured
Spot; Stahl, schwarz, kupferfarben-antik
spot; acier, noir, aspect cuivre-antique

Ø 160, A 255



E27



1x 40W



9 002759 437152



A 255

Ø 160

43718 CARLTON 7

spot; steel, black, antique copper coloured
Spot; Stahl, schwarz, kupferfarben-antik
spot; acier, noir, aspect cuivre-antique

L 370, B 370, H 255



E27



4x 40W



9 002759 437183



L 370

B 370



43057



43399



43058

43057 CARLTON 4

wall light; steel, black, antique copper coloured
Wandleuchte; Stahl, schwarz, kupferfarben-antik
Applique; acier, noir, aspect cuivre-antique

L 160, H 315, A 225



E27 1x 60W



9 002759 430573



43058 CARLTON 4

table light; steel, black, antique copper coloured
Tischleuchte; Stahl, schwarz, kupferfarben-antik
luminaire de table; acier, noir, aspect cuivre-antique

L 220, B 160, H 505, Base: Ø 170

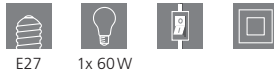

E27 1x 60W



9 002759 430580



43399 CARLTON 6

ceiling light; steel, black, copper
Deckenleuchte; Stahl, schwarz, kupfer
plafonnier; acier, noir, cuivre

H 235, Ø 470



E27 1x 60W



9 002759 433994

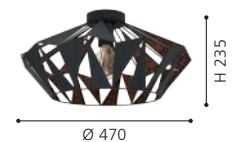



43077

43077 CARLTON 5

table light; steel, black, copper / fabric, black, copper
Tischleuchte; Stahl, schwarz, kupfer / Textil, schwarz, kupfer
luminaire de table; acier, noir, cuivre / tissu, noir, cuivre

H 510, Ø 250



E27



1x 60W



9 002759 430771



49932



43002

49932 CARLTON 1

pendant light; steel, white, honey gold
Hängeleuchte; Stahl, weiss, honiggold
luminaire en suspension; acier, blanc, or

H 1100, Ø 310



E27 1x 60W



9 002759 499327



43002 CARLTON 1

pendant light; steel, white, gold
Hängeleuchte; Stahl, weiss, gold
luminaire en suspension; acier, blanc, or

L 805, B 205, H 1100



E27 3x 60W



9 002759 430023



43001 CARLTON 1

pendant light; steel, white, gold
Hängeleuchte; Stahl, weiss, gold
luminaire en suspension; acier, blanc, or

H 1100, Ø 205



E27 1x 60W



9 002759 430016





43001





49024



49026

49024 CARLTON-P

pendant light; steel, pastel apricot
 Hängeleuchte; Stahl, Pastell apricot
 luminaire en suspension; acier, Pastel abricot

H 1500, Ø 310



E27 1x 60W



9 002759 490249



49026 CARLTON-P

pendant light; steel, pastel light green
 Hängeleuchte; Stahl, Pastell hellgrün
 luminaire en suspension; acier, pastel vert clair

H 1500, Ø 310



E27 1x 60W



9 002759 490263



49931 CARLTON 1

pendant light; steel, black, gold
 Hängeleuchte; Stahl, schwarz, gold
 luminaire en suspension; acier, noir, or

H 1100, Ø 310



E27 1x 60W



9 002759 499310





49931



43909



43908

43909 CARLTON

pendant light; steel, gold-coloured
Hängeleuchte; Stahl, goldfarben
luminaire en suspension; acier, or

L 805, B 205, H 1100



E27



3x 60W



9 002759 439095



43908 CARLTON

ceiling light; steel, gold-coloured
Deckenleuchte; Stahl, goldfarben
plafonnier; acier, or

H 235, Ø 470



E27



1x 60W



9 002759 439088





43815

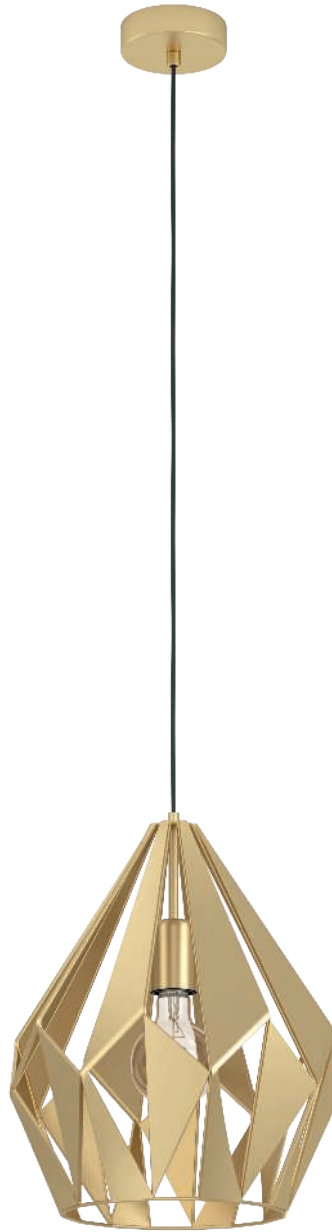

43814

43815 CARLTON

pendant light; steel, gold-coloured
Hängeleuchte; Stahl, goldfarben
luminaire en suspension; acier, or

H 1100, Ø 385



E27



1x 60W



9 002759 438159



43814 CARLTON

pendant light; steel, gold-coloured
Hängeleuchte; Stahl, goldfarben
luminaire en suspension; acier, or

H 1100, Ø 310



E27



1x 60W



9 002759 438142





49258



49259



49933

49258 CARLTON

pendant light; steel, copper-coloured
Hängeleuchte; Stahl, kupferfarben
luminaire en suspension; acier, cuivré

H 1100, Ø 310



E27 1x 60W



9 002759 492588



49259 CARLTON

pendant light; steel, mint
Hängeleuchte; Stahl, mint
luminaire en suspension; acier, menthe

H 1100, Ø 310



E27 1x 60W



9 002759 492595



49933 CARLTON

pendant light; steel, gold-coloured
Hängeleuchte; Stahl, goldfarben
luminaire en suspension; acier, or

H 1100, Ø 310



E27 1x 60W



9 002759 499334





49257 CARLTON

pendant light; steel, black
Hängeleuchte; Stahl, schwarz
luminaire en suspension; acier, noir

H 1100, Ø 310



E27



1x 60W



9 002759 492571



DESIGN
HIGHLIGHT
DETAIL





43692

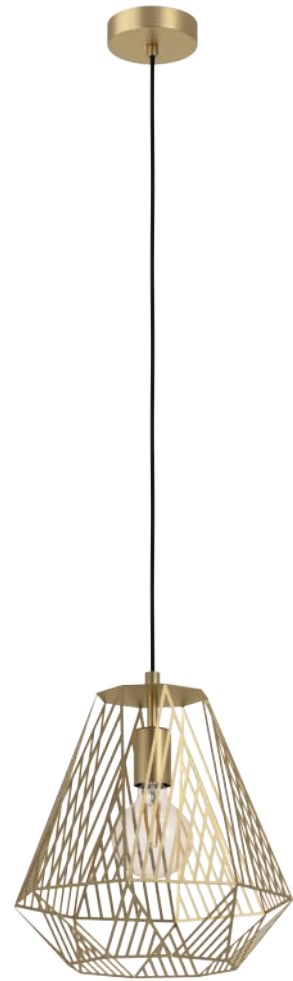

43695

43692 STYPE

pendant light; steel, black
 Hängeleuchte; Stahl, schwarz
 luminaire en suspension; acier, noir

H 1100, Ø 330



E27



1x 40W



9 002759 436926



43695 STYPE

pendant light; steel, gold-coloured
 Hängeleuchte; Stahl, goldfarben
 luminaire en suspension; acier, or

H 1100, Ø 330



E27



1x 40W



9 002759 436957





43696



43693

43696 STYPE

pendant light; steel, gold-coloured
Hängeleuchte; Stahl, goldfarben
luminaire en suspension; acier, or

L 960, B 200, H 1100



E27



3x 40W



9 002759 436964



L 960

H 1100

43693 STYPE

pendant light; steel, black
Hängeleuchte; Stahl, schwarz
luminaire en suspension; acier, noir

L 960, B 200, H 1100



E27



3x 40W



9 002759 436933



L 960

H 1100



43359



43361

43359 STRAITON

pendant light; steel, black
Hängeleuchte; Stahl, schwarz
luminaire en suspension; acier, noir

H 1100, Ø 515



E27 1x 60W



9 002759 433598



43361 STRAITON

pendant light; steel, black
Hängeleuchte; Stahl, schwarz
luminaire en suspension; acier, noir

L 905, B 240, H 1100



E27 3x 60W



9 002759 433611

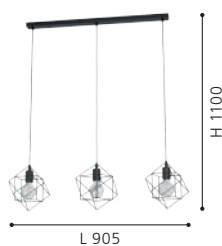

43358 STRAITON

pendant light; steel, black
Hängeleuchte; Stahl, schwarz
luminaire en suspension; acier, noir

L 240, B 205, H 1100



E27 1x 60W



9 002759 433581

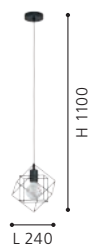



43358



43481



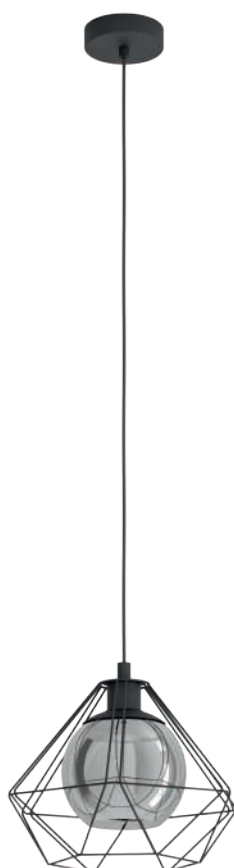

43482



43483

43481 VERNHAM

pendant light; steel, black / glass vaporized, black-transparent
 Hängeleuchte; Stahl, schwarz / Glas bedampft, schwarz-transparent
 luminaire en suspension; acier, noir / verre vaporisé, noir transparent

H 1100, Ø 445



E27 1x 40W



9 002759 434816

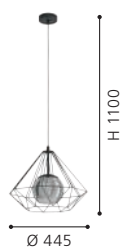

43482 VERNHAM

pendant light; steel, black / glass vaporized, black-transparent
 Hängeleuchte; Stahl, schwarz / Glas bedampft, schwarz-transparent
 luminaire en suspension; acier, noir / verre vaporisé, noir transparent

H 1100, Ø 325



E27 1x 40W



9 002759 434823



43483 VERNHAM

pendant light; steel, black / glass vaporized, black-transparent
 Hängeleuchte; Stahl, schwarz / Glas bedampft, schwarz-transparent
 luminaire en suspension; acier, noir / verre vaporisé, noir transparent

L 1145, B 325, H 1100



E27 3x 40W



9 002759 434830

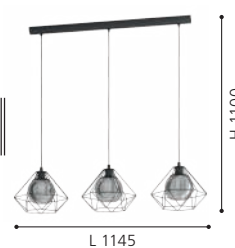



43004

DESIGN
HIGHLIGHT
DETAIL



49081

43004 TARBES

ceiling light; steel, black
Deckenleuchte; Stahl, schwarz
plafonnier; acier, noir

H 275, Ø 325



E27 1x 60W



9 002759 430047



49081 TARBES

wall light; steel, black
Wandleuchte; Stahl, schwarz
Applique; acier, noir

L 155, H 375, A 275



E27 1x 60W



9 002759 490812



49487 CARLTON 2

pendant light; steel, black
Hängeleuchte; Stahl, schwarz
luminaire en suspension; acier, noir

H 1100, Ø 455



E27 1x 60W



9 002759 494872





49487



43766



43767

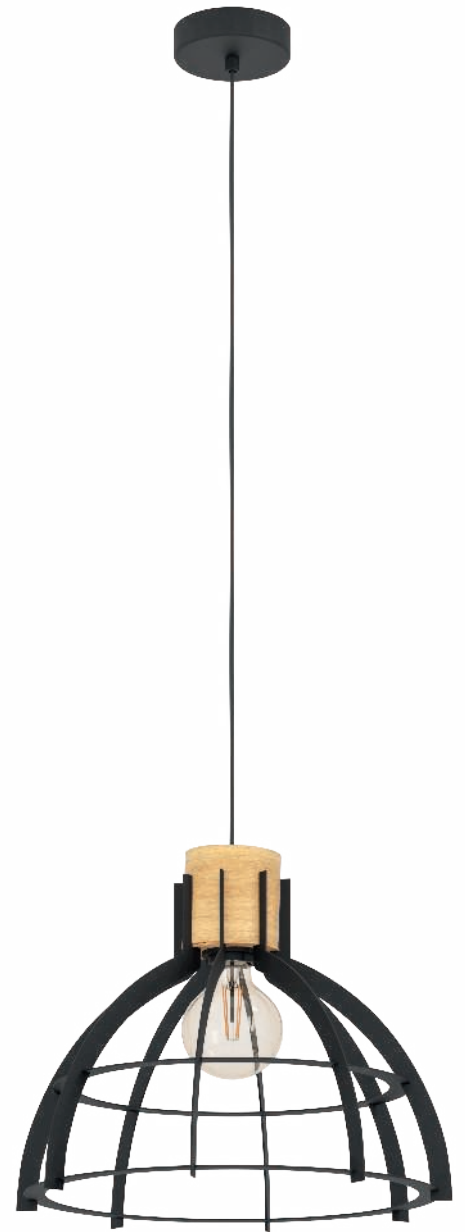

43769

43766 STILLINGTON

ceiling light; steel, black, gold
Deckenleuchte; Stahl, schwarz, gold
plafonnier; acier, noir, or

H 315, Ø 415



E27 1x 40W



9 002759 437664



43767 STILLINGTON

pendant light; steel, black, gold
Hängeleuchte; Stahl, schwarz, gold
luminaire en suspension; acier, noir, or

H 1100, Ø 415



E27 1x 40W



9 002759 437671



43769 STILLINGTON

pendant light; steel, wood, black, brown
Hängeleuchte; Stahl, Holz, schwarz, braun
luminaire en suspension; acier, bois, noir, marron

H 1100, Ø 415



E27 1x 40W



9 002759 437695





43768

43768 STILLINGTON

ceiling light; steel, wood, black, brown
Deckenleuchte; Stahl, Holz, schwarz, braun
plafonnier; acier, bois, noir, marron

H 315, Ø 415



E27



1x 40W



9 002759 437688

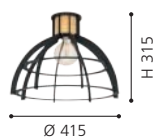



43928
 FSC



43926
 FSC



43927
 FSC

43926 STILLINGTON 1

spot; steel, wood, black, brown
 Spot; Stahl, Holz, schwarz, braun
 spot; acier, bois, noir, marron

H 245, Ø 160



9 002759 439262

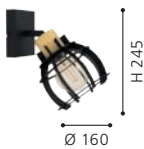

43928 STILLINGTON 1

spot; steel, wood, black, brown
 Spot; Stahl, Holz, schwarz, braun
 spot; acier, bois, noir, marron

L 710, B 160, H 245



9 002759 439286



43927 STILLINGTON 1

spot; steel, wood, black, brown
 Spot; Stahl, Holz, schwarz, braun
 spot; acier, bois, noir, marron

L 420, B 160, H 245



9 002759 439279





43925



43925 STILLINGTON 1

pendant light; steel, wood, black, brown
 Hängeleuchte; Stahl, Holz, schwarz, braun
 luminaire en suspension; acier, bois, noir, marron

L 880, B 180, H 1100



E27



3x 40W



9 002759 439255



DESIGN
 HIGHLIGHT
 DETAIL

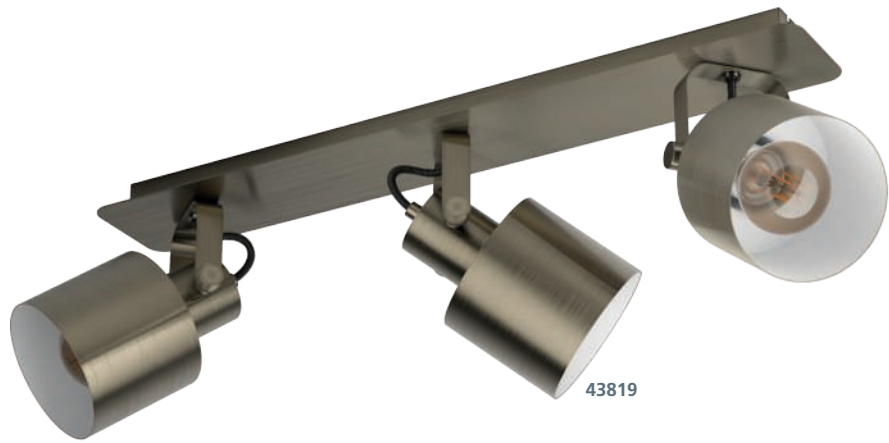

43819



43818



43817

43819 SOUTHERY

spot; steel, brushed creme-gold, white
Spot; Stahl, creme-gold gebürstet, weiss
spot; acier, or crème brossé, blanc

L 700, B 110, H 210



E27 3x 40W



9 002759 438197

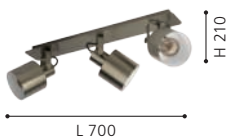

L 700

H 210

43818 SOUTHERY

spot; steel, brushed creme-gold, white
Spot; Stahl, creme-gold gebürstet, weiss
spot; acier, or crème brossé, blanc

L 470, B 110, H 210



E27 2x 40W



9 002759 438180



L 470

H 210

43817 SOUTHERY

spot; steel, brushed creme-gold, white
Spot; Stahl, creme-gold gebürstet, weiss
spot; acier, or crème brossé, blanc

L 185, B 110, H 210



E27 1x 40W



9 002759 438173

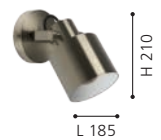

L 185

H 210



43816

43816 SOUTHERY

pendant light; steel, brushed creme-gold, white
Hängeleuchte; Stahl, creme-gold gebürstet, weiss
luminaire en suspension; acier, or crème brossé, blanc

H 1100, Ø 350



E27



1x 40W



9 002759 438166





44028



DETAIL LINTMILL

The brushed brass shade is adjustable.
 Die gebürstete Messingscheibe ist verstellbar.
 Le disque en laiton brossé est réglable.



44027

44028 LINTMILL

wall/ceiling light; steel, black / glass, grey
 Wand- / Deckenleuchte; Stahl, schwarz / Glas, grau
 Applique/Plafonnier; acier, noir / verre, gris

H 75, Ø 300



44027 LINTMILL

ceiling light; steel, black, brushed brass / glass, grey
 Deckenleuchte; Stahl, schwarz, messing-gebürstet / Glas, grau
 plafonnier; acier, noir, laiton brossé / verre, gris

H 200, Ø 530

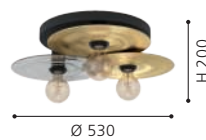

44029 LINTMILL

pendant light; steel, black / steel, brushed brass
 Hängeleuchte; Stahl, schwarz / Stahl, messing-gebürstet
 luminaire en suspension; acier, noir / acier, laiton brossé

H 1100, Ø 400

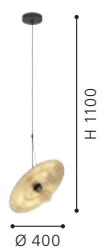



44029



43443



DETAIL 43599

These ceiling luminaires have a great play of light.

Diese Deckenleuchten verfügen über ein tolles Lichtspiel.

Ces plafonniers disposent d'un superbe jeu de lumière.

43443 CASTANUELO

wall/ceiling light; steel, gold
Wand- / Deckenleuchte; Stahl, gold
Applique/Plafonnier; acier, or

H 105, Ø 425



E27



1x 40W



9 002759 434434



Ø 425

H 105



43599



43808



43809

43599 CASTANUELO

wall/ceiling light; steel, gold
Wand- / Deckenleuchte; Stahl, gold
Applique/Plafonnier; acier, or

H 100, Ø 425



E27



1x 40W



9 002759 435998



H 100

Ø 425

43808 CASTANUELO

table light; steel, black, gold
Tischleuchte; Stahl, schwarz, gold
luminaire de table; acier, noir, or

L 370, B 270, H 575, Base: Ø 295



E27



1x 40W



9 002759 438081

L 370



H 575

Ø 295

43809 CASTANUELO

floor light; steel, black, gold
Stehleuchte; Stahl, schwarz, gold
lampadaire; acier, noir, or

L 500, B 270, H 1520, Base: Ø 745



E27



1x 40W



9 002759 438098

L 500



H 1520

Ø 745



43679

43679 TARBES

pendant light; steel, brushed brass
Hängeleuchte; Stahl, messing-gebürstet
luminaire en suspension; acier, laiton brossé

H 1100, Ø 325



E27



1x 60W



9 002759 436797





43678



43681



43682

43678 TARDES

ceiling light; steel, brushed brass
Deckenleuchte; Stahl, messing-gebürstet
plafonnier; acier, laiton brossé

H 275, Ø 325



E27



1x 60W



9 002759 436780



Ø 325

H 275

43681 TARDES

pendant light; steel, brushed brass
Hängeleuchte; Stahl, messing-gebürstet
luminaire en suspension; acier, laiton brossé

H 1300, Ø 175



E27



1x 60W



9 002759 436810



Ø 175

H 1300

43682 TARDES

pendant light; steel, brushed brass
Hängeleuchte; Stahl, messing-gebürstet
luminaire en suspension; acier, laiton brossé

L 795, B 175, H 1300



E27



3x 60W



9 002759 436827



L 795

H 1300



94191



94187

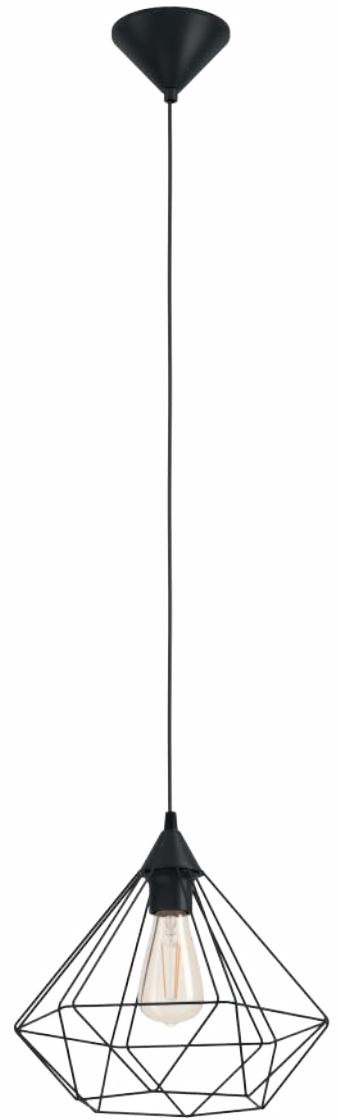

94188

94191 TARDES

pendant light; steel, black / steel, black
Hängeleuchte; Stahl, schwarz / Stahl, schwarz
luminaire en suspension; acier, noir / acier, noir

H 1100, Ø 310



E27 3x 60W



9 002759 941918



94187 TARDES

pendant light; plastic, black / steel, black
Hängeleuchte; Kunststoff, schwarz / Stahl, schwarz
luminaire en suspension; plastique, noir / acier, noir

H 1100, Ø 175



E27 1x 60W



9 002759 941871

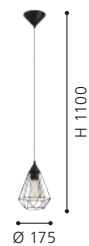

94188 TARDES

pendant light; plastic, black / steel, black
Hängeleuchte; Kunststoff, schwarz / Stahl, schwarz
luminaire en suspension; plastique, noir / acier, noir

H 1100, Ø 325



E27 1x 60W



9 002759 941888





94189



94192

94189 TARBES

pendant light; steel, black / steel, black
 Hängeleuchte; Stahl, schwarz / Stahl, schwarz
 luminaire en suspension; acier, noir / acier, noir

L 790, B 175, H 1100



E27



3x 60W



9 002759 941895



L 790

H 1100

94192 TARBES

table light; steel, black / steel, black
 Tischleuchte; Stahl, schwarz / Stahl, schwarz
 luminaire de table; acier, noir / acier, noir

H 265, Ø 175



E27



1x 60W



9 002759 941925



H 265

Ø 175



94194

94195

94194 TARDES

pendant light; plastic, black / steel, copper-coloured
 Hängeleuchte; Kunststoff, schwarz / Stahl, kupferfarben
 luminaire en suspension; plastique, noir / acier, cuivré

H 1100, Ø 325



E27 1x 60W



9 002759 941949



94195 TARDES

pendant light; steel, black / steel, copper-coloured
 Hängeleuchte; Stahl, schwarz / Stahl, kupferfarben
 luminaire en suspension; acier, noir / acier, cuivré

L 790, B 175, H 1100



E27 3x 60W



9 002759 941956

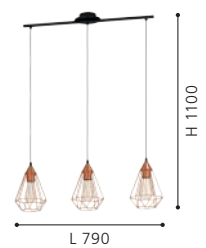



94196



94193

94196 TARBES

pendant light; steel, black / steel, copper-coloured
Hängeleuchte; Stahl, schwarz / Stahl, kupferfarben
luminaire en suspension; acier, noir / acier, cuivré

H 1100, Ø 310



E27



3x 60W



9 002759 941963

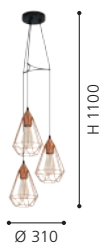

H 1100

Ø 310

94193 TARBES

pendant light; plastic, black / steel, copper-coloured
Hängeleuchte; Kunststoff, schwarz / Stahl, kupferfarben
luminaire en suspension; plastique, noir / acier, cuivré

H 1100, Ø 175



E27



1x 60W



9 002759 941932



H 1100

Ø 175



49644

49645

49646

49644 ROCCAMENA

pendant light; steel, black, copper
 Hängeleuchte; Stahl, schwarz, kupfer
 luminaire en suspension; acier, noir, cuivre

H 1100, Ø 130



E27 1x 60W



9 002759 496449

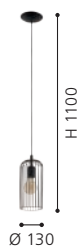

49645 ROCCAMENA

pendant light; steel, black, copper
 Hängeleuchte; Stahl, schwarz, kupfer
 luminaire en suspension; acier, noir, cuivre

L 730, B 130, H 1100



E27 3x 60W



9 002759 496456



49646 ROCCAMENA

table light; steel, black, copper
 Tischleuchte; Stahl, schwarz, kupfer
 luminaire de table; acier, noir, cuivre

H 310, Ø 130, Base: Ø 130



E27 1x 60W



9 002759 496463





49142

49142 CLEVEDON

pendant light; steel, black
Hängeleuchte; Stahl, schwarz
luminaire en suspension; acier, noir

L 780, B 170, H 1100



E27



3x 60W



9 002759 491420

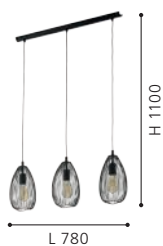



49472



49477

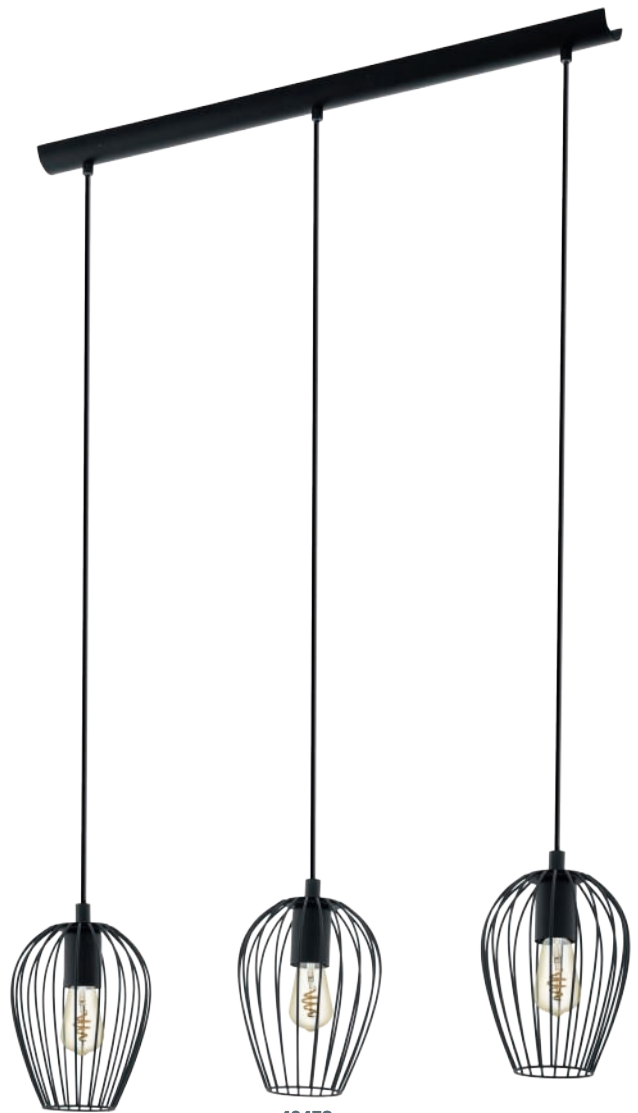

49478

49472 NEWTOWN

pendant light; steel, black
Hängeleuchte; Stahl, schwarz
luminaire en suspension; acier, noir

H 1100, Ø 275



E27



1x 60W



9 002759 494728



49477 NEWTOWN

pendant light; steel, black
Hängeleuchte; Stahl, schwarz
luminaire en suspension; acier, noir

H 1100, Ø 160



E27



1x 60W



9 002759 494773



49478 NEWTOWN

pendant light; steel, black
Hängeleuchte; Stahl, schwarz
luminaire en suspension; acier, noir

L 700, B 160, H 1100



E27



3x 60W



9 002759 494780





49479



49481



49474

49479 NEWTOWN

pendant light; steel, black
Hängeleuchte; Stahl, schwarz
luminaire en suspension; acier, noir

H 1300, Ø 380



E27



3x 60W



9 002759 494797



H 1300

Ø 380

49481 NEWTOWN

table light; steel, black
Tischleuchte; Stahl, schwarz
luminaire de table; acier, noir

H 230, Ø 160, Base: Ø 120



E27



1x 60W



9 002759 494810



Ø 160

H 230

Ø 120

49474 NEWTOWN

floor light; steel, black
Stehleuchte; Stahl, schwarz
lampadaire; acier, noir

H 1595, Ø 275, Base: Ø 230



E27



1x 60W



9 002759 494742



Ø 275

H 1595

Ø 230

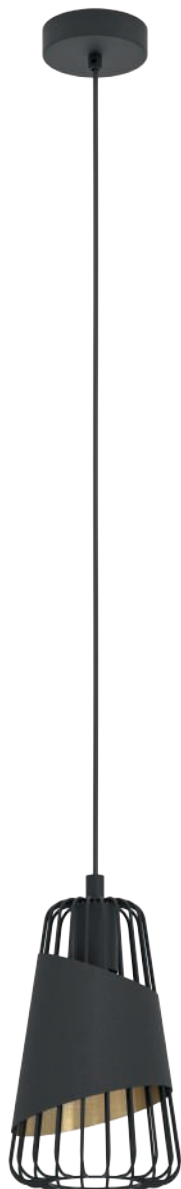

49447



49448

49447 AUSTELL

pendant light; steel, black / steel, fabric, black, gold
 Hängeleuchte; Stahl, schwarz / Stahl, Textil, schwarz, gold
 luminaire en suspension; acier, noir / acier, tissu, noir, or

H 1100, Ø 165



E27 1x 60W



9 002759 494476

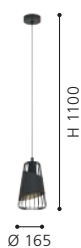

49448 AUSTELL

pendant light; steel, black / steel, fabric, black, gold
 Hängeleuchte; Stahl, schwarz / Stahl, Textil, schwarz, gold
 luminaire en suspension; acier, noir / acier, tissu, noir, or

L 765, B 165, H 1100



E27 3x 60W



9 002759 494483



49446 AUSTELL

pendant light; steel, black / steel, fabric, black, gold
 Hängeleuchte; Stahl, schwarz / Stahl, Textil, schwarz, gold
 luminaire en suspension; acier, noir / acier, tissu, noir, or

H 1100, Ø 360



E27 1x 60W



9 002759 494469





49446



43848





43847



43849



43848 PLIMSOLL

pendant light; steel, wood, black
Hängeleuchte; Stahl, Holz, schwarz
luminaire en suspension; acier, bois, noir

L 770, B 95, H 1100



E27



4x 15W



9 002759 438487

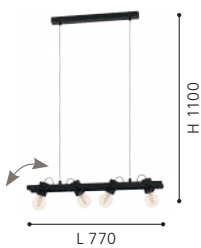

43847 PLIMSOLL

ceiling light; steel, wood, black
Deckenleuchte; Stahl, Holz, schwarz
plafonnier; acier, bois, noir

L 770, B 95, H 165



E27



4x 15W



9 002759 438470



43849 PLIMSOLL

table light; steel, wood, black
Tischleuchte; Stahl, Holz, schwarz
luminaire de table; acier, bois, noir

L 105, B 75, H 255, Base: Ø 135



E27



1x 15W



9 002759 438494





44006



44005



44007

44006 WAVERTON

pendant light; steel, black / fabric, wood, white, black
 Hängeleuchte; Stahl, schwarz / Textil, Holz, weiss, schwarz
 luminaire en suspension; acier, noir / tissu, bois, blanc, noir

H 1100, Ø 480



E27 1x 40W



9 002759 440060



44005 WAVERTON

pendant light; steel, black / fabric, wood, white, black
 Hängeleuchte; Stahl, schwarz / Textil, Holz, weiss, schwarz
 luminaire en suspension; acier, noir / tissu, bois, blanc, noir

H 1100, Ø 400



E27 1x 40W



9 002759 440053



44007 WAVERTON

pendant light; steel, black / fabric, wood, white, black
 Hängeleuchte; Stahl, schwarz / Textil, Holz, weiss, schwarz
 luminaire en suspension; acier, noir / tissu, bois, blanc, noir

L 920, B 220, H 1100



E27 3x 40W



9 002759 440077

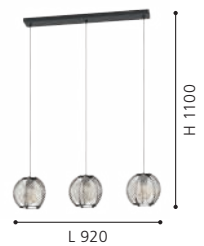



44008



44009

44008 WAVERTON

table light; steel, black / fabric, wood, white, black
 Tischleuchte; Stahl, schwarz / Textil, Holz, weiss, schwarz
 luminaire de table; acier, noir / tissu, bois, blanc, noir

H 400, Ø 220, Base: Ø 225



E27



1x 40W



9 002759 440084



44009 WAVERTON

floor light; steel, black / fabric, wood, white, black
 Stehleuchte; Stahl, schwarz / Textil, Holz, weiss, schwarz
 lampadaire; acier, noir / tissu, bois, blanc, noir

H 1430, Ø 400, Base: Ø 665



E27



1x 40W



9 002759 440091





43426



43427



DETAIL HORNWOOD 1

The heads can be adjusted or fixed in position with the lateral screws.
Die Köpfe können mittels den seitlichen Schrauben verstellt oder fixiert werden.
Les têtes peuvent être réglées ou fixées à l'aide des vis latérales.

43426 HORNWOOD 1

pendant light; steel, wood, black / fabric, white
Hängeleuchte; Stahl, Holz, schwarz / Textil, weiss
luminaire en suspension; acier, bois, noir / tissu, blanc

L 780, B 195, H 1100



E27



3x 28W



9 002759 434267

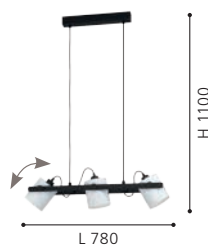

43427 HORNWOOD 1

wall light; steel, wood, black / fabric, white
Wandleuchte; Stahl, Holz, schwarz / Textil, weiss
Applique; acier, bois, noir / tissu, blanc

L 195, A 255



E27



1x 28W



9 002759 434274

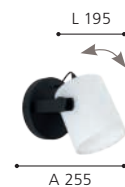



44098



44114



44115



44098 BIDFORD

floor light; wood, steel, brown / fabric, cappuccino, gold
 Stehleuchte; Holz, Stahl, braun / Textil, cappuccino, gold
 lampadaire; bois, acier, marron / tissu, cappuccino, or

H 1540, Ø 460, Base: Ø 700



E27



1x 60W



9 002759 440985

44114 LANTADA

floor light; wood, steel, natural / fabric, beige
 Stehleuchte; Holz, Stahl, natur / Textil, beige
 lampadaire; bois, acier, naturel / tissu, beige

H 1430, Ø 450, Base: Ø 975



E27



1x 60W



9 002759 441142

44115 LANTADA

floor light; wood, steel, nut / fabric, taupe
 Stehleuchte; Holz, Stahl, nuss / Textil, taupe
 lampadaire; bois, acier, noisette / tissu, taupe

H 1430, Ø 450, Base: Ø 975



E27



1x 60W



9 002759 441159



DESIGN
HIGHLIGHT
DETAIL

49386 CHESTER

floor light; steel, black, copper
Stehleuchte; Stahl, schwarz, kupfer
lampadaire; acier, noir, cuivre

H 1495, Base: Ø 600



E27



1x 60W

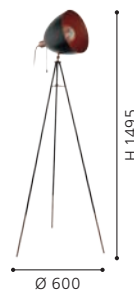

9 002759 493868

49519 CHESTER 1

floor light; steel, rust-coloured, gold
Stehleuchte; Stahl, rostfarben, gold
lampadaire; acier, rouille, or

H 1495, Base: Ø 600



E27



1x 60W



9 002759 495190

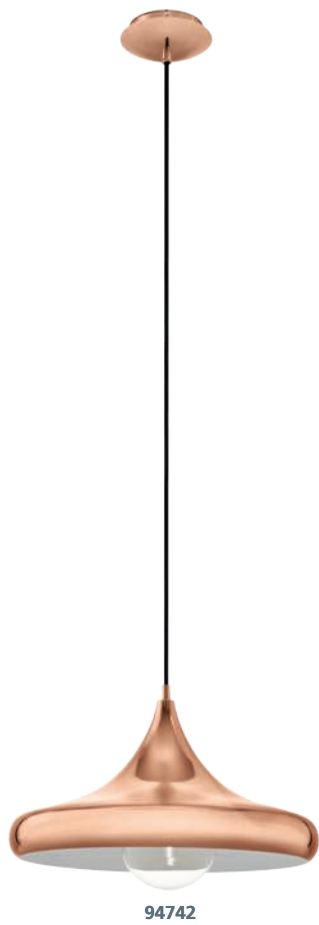

94742



49449

94742 CORETTO 2

pendant light; steel, copper
Hängeleuchte; Stahl, kupfer
luminaire en suspension; acier, cuivre

H 1100, Ø 400



E27



1x 60W



9 002759 947422

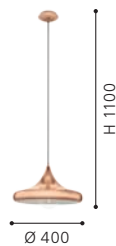

49449 HAPTON

pendant light; steel, copper
Hängeleuchte; Stahl, kupfer
luminaire en suspension; acier, cuivre

H 1100, Ø 290



E27



1x 60W



9 002759 494490

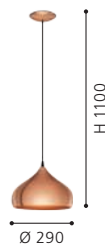



43633



43634

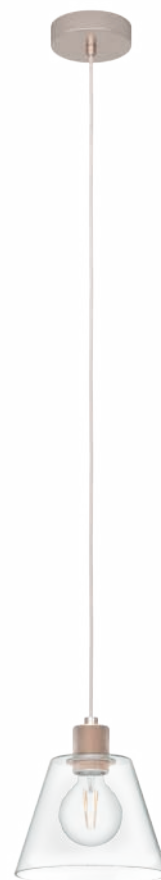

43631

43633 COPLEY

pendant light; steel, aluminium, gold-coloured / glass, clear
Hängeleuchte; Stahl, Alu, goldfarben / Glas, klar
luminaire en suspension; acier, aluminium, or / verre,
transparent

H 1100, Ø 200



E27 1x 40W



9 002759 436339



43634 COPLEY

pendant light; steel, aluminium, gold-coloured / glass, clear
Hängeleuchte; Stahl, Alu, goldfarben / Glas, klar
luminaire en suspension; acier, aluminium, or / verre,
transparent

L 900, B 200, H 1100



E27 3x 40W



9 002759 436346



43631 COPLEY

pendant light; steel, aluminium, rose gold / glass, clear
Hängeleuchte; Stahl, Alu, roségold / Glas, klar
luminaire en suspension; acier, aluminium, rose or / verre,
transparent

H 1100, Ø 200



E27 1x 40W



9 002759 436315





43632

43632 COPLEY

pendant light; steel, aluminium, rose gold / glass, clear
Hängeleuchte; Stahl, Alu, roségold / Glas, klar
luminaire en suspension; acier, aluminium, rose or / verre,
transparent

L 900, B 200, H 1100



E27



3x 40W



9 002759 436322

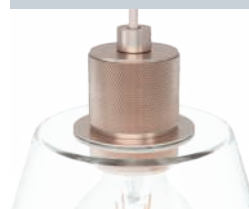
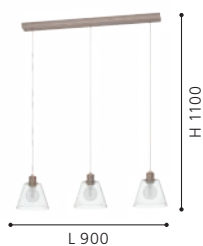

DETAIL COPLEY

These luminaires have a special socket.

Diese Leuchten verfügen über eine spezielle Fassung.

Ces luminaires disposent d'une douille spéciale.



43331



43333

43331 WRINGTON

pendant light; steel, black
Hängeleuchte; Stahl, schwarz
luminaire en suspension; acier, noir

H 1100, Ø 300



E27



1x 60W



9 002759 433314



43333 WRINGTON

pendant light; steel, black
Hängeleuchte; Stahl, schwarz
luminaire en suspension; acier, noir

L 740, B 150, H 1100



E27



3x 60W



9 002759 433338

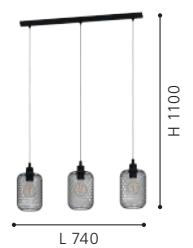



43096



32468

43096 WRINGTON

table light; steel, black
Tischleuchte; Stahl, schwarz
luminaire de table; acier, noir

H 285, Ø 150, Base: Ø 100



E27



1x 60W



9 002759 430962



32468 WRINGTON

floor light; steel, black
Stehleuchte; Stahl, schwarz
lampadaire; acier, noir

L 635, B 300, H 1940, Base: Ø 300



E27



1x 60W



9 002759 324681





43305

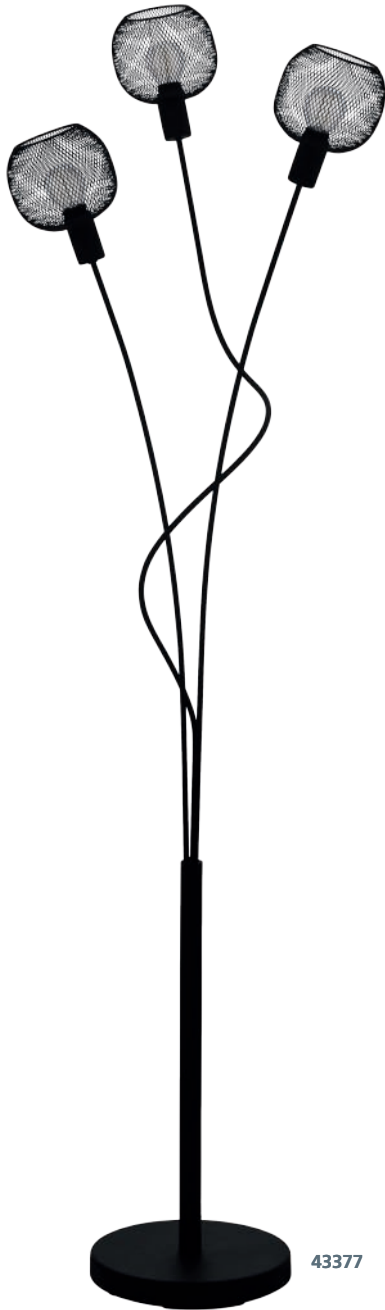

43377

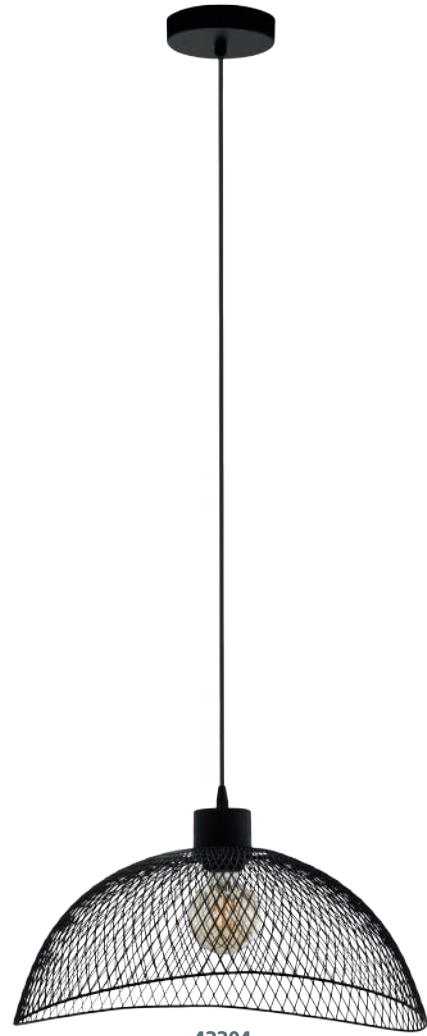

43304

43305 POMPEYA

pendant light; steel, black
Hängeleuchte; Stahl, schwarz
luminaire en suspension; acier, noir

L 570, B 540, H 1100



E27



1x 60W



9 002759 433055



H 1100

L 570

43377 WRINGTON 1

floor light; steel, black
Stehleuchte; Stahl, schwarz
lampadaire; acier, noir

L 340, B 305, H 1495, Base: Ø 230



E14



3x 40W



9 002759 433772



L 340

H 1495

Ø 230

43304 POMPEYA

pendant light; steel, black
Hängeleuchte; Stahl, schwarz
luminaire en suspension; acier, noir

L 450, B 440, H 1100



E27



1x 60W



9 002759 433048



H 1100

L 450



43669

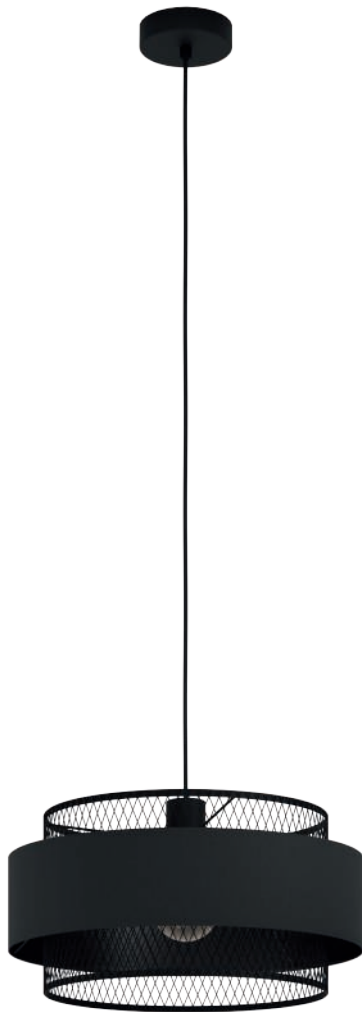

43668



43559

43669 BAZELY

pendant light; steel, black / fabric, black
 Hängeleuchte; Stahl, schwarz / Textil, schwarz
 luminaire en suspension; acier, noir / tissu, noir

L 990, B 230, H 1100



E27



3x 40W



9 1002759 436681



43668 BAZELY

pendant light; steel, black / fabric, black
 Hängeleuchte; Stahl, schwarz / Textil, schwarz
 luminaire en suspension; acier, noir / tissu, noir

H 1100, Ø 400



E27



1x 40W



9 1002759 436681



43559 SALLICANO

pendant light; steel, black, gold
 Hängeleuchte; Stahl, schwarz, gold
 luminaire en suspension; acier, noir, or

L 730, B 200, H 1100



E27



3x 40W



9 1002759 435592

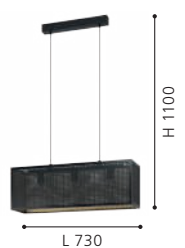

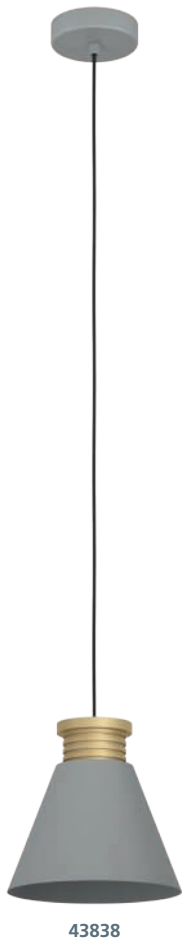

43838 TWICKEN

pendant light; steel, grey, gold
Hängeleuchte; Stahl, grau, gold
luminaire en suspension; acier, gris, or

H 1100, Ø 220



E27 1x 40W



9 002759 438388



43839 TWICKEN

pendant light; steel, grey, gold
Hängeleuchte; Stahl, grau, gold
luminaire en suspension; acier, gris, or

L 920, B 220, H 1100



E27 3x 40W



9 002759 438395

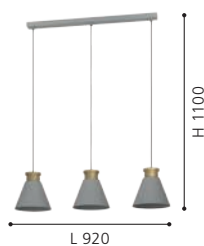

43841 TWICKEN

table light; steel, grey, gold
Tischleuchte; Stahl, grau, gold
luminaire de table; acier, gris, or

L 155, B 150, H 195, Base: B 150



E27 1x 28W



9 002759 438418





43835



43836



43837

43835 TWICKEN

spot; steel, grey, gold
Spot; Stahl, grau, gold
spot; acier, gris, or

L 180, B 150, H 200



E27



1x 28W



9 002759 438357

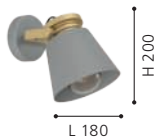

L 180

H 200

43836 TWICKEN

spot; steel, grey, gold
Spot; Stahl, grau, gold
spot; acier, gris, or

L 370, B 205, H 175



E27



2x 40W



9 002759 438364



L 370

H 175

43837 TWICKEN

spot; steel, grey, gold
Spot; Stahl, grau, gold
spot; acier, gris, or

L 590, B 205, H 175



E27



3x 40W



9 002759 438371



L 590

H 175



43825



DESIGN
HIGHLIGHT
DETAIL

43825 MATLOCK

pendant light; steel, grey, black
Hängeleuchte; Stahl, grau, schwarz
luminaire en suspension; acier, gris, noir

H 1100, Ø 380



E27



1x 40W



9 002759 438258

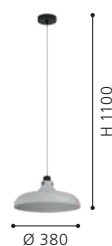

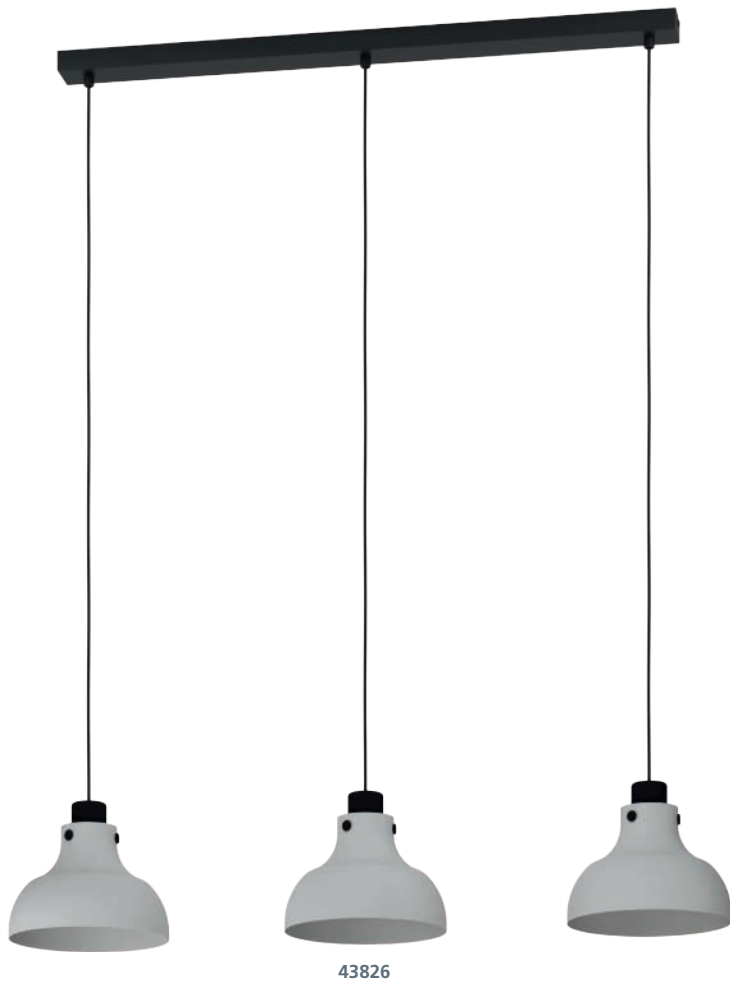

43826



43842

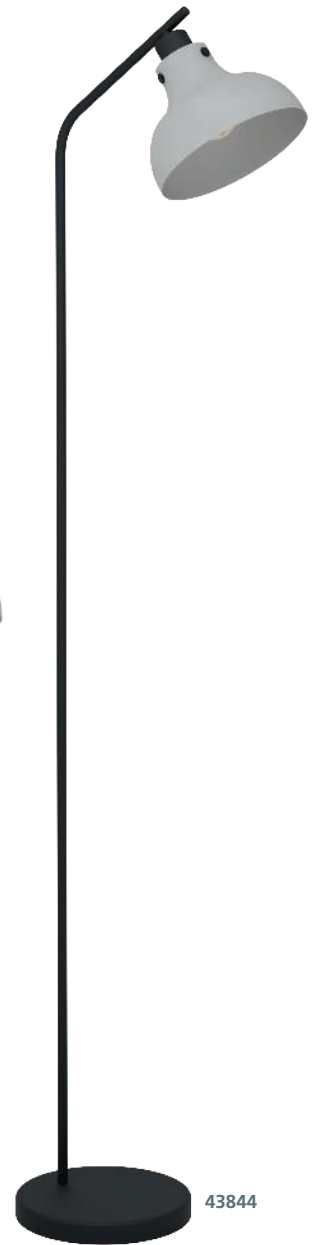

43844

43826 MATLOCK

pendant light; steel, grey, black
 Hängeleuchte; Stahl, grau, schwarz
 luminaire en suspension; acier, gris, noir

L 900, B 200, H 1100



E27 3x 40W



9 002759 438265



L 900

H 1100

43842 MATLOCK

ceiling light; steel, grey, black
 Deckenleuchte; Stahl, grau, schwarz
 plafonnier; acier, gris, noir

H 210, Ø 380



E27 1x 40W



9 002759 438425



Ø 380

H 210

43844 MATLOCK

floor light; steel, grey, black
 Stehleuchte; Stahl, grau, schwarz
 lampadaire; acier, gris, noir

L 405, B 200, H 1580, Base: B 230



E27 1x 40W



9 002759 438449

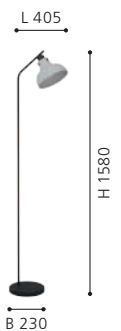

L 405

B 230

H 1580



43829



43827



43828

43829 MATLOCK

spot; steel, wood, grey, black
Spot; Stahl, Holz, grau, schwarz
spot; acier, bois, gris, noir

L 740, B 145, H 225



E27



3x 40W



9 002759 438296



L 740

H 225

43828 MATLOCK

spot; steel, wood, grey, black
Spot; Stahl, Holz, grau, schwarz
spot; acier, bois, gris, noir

L 520, B 145, H 225



E27



2x 40W



9 002759 438289



L 520

H 225

43827 MATLOCK

spot; steel, grey, black
Spot; Stahl, grau, schwarz
spot; acier, gris, noir

L 245, B 145, H 225



E27



1x 40W



9 002759 438272



L 245

H 225



43843

43843 MATLOCK

wall light; steel, grey, black
Wandleuchte; Stahl, grau, schwarz
Applique; acier, gris, noir

L 200, H 250, A 800



E27



1x 40W



9 002759 438432

